

# ENSTO

## Spare parts catalog

MV Load Break Switch

*LBS SPEN Auguste*



**Better life.**  
With electricity.

Ensto designs and markets smart electrical solutions to improve the safety, functionality, reliability and effectiveness of Smart Grids, buildings and transport.

[ensto.com](http://ensto.com)



# SUMMARY

1 - Complete load break switch.....	4
2 - Surge arrester .....	4
3 - HV network connection .....	5
4 - Switch - Pole fixing .....	6
5 - Motorized mechanism .....	7
6 - Lower cover .....	9
7 - Safety manual command.....	10
8 - Options .....	10
9 - Accessories .....	10
10 - Entire ITI Control box for AUGUSTE .....	12
11 - Control box -Pole fixing .....	12
12 - Control box - Backplane board .....	13
13 - Control box - Display board .....	13
14 - Control board - Charger board .....	13
15 - Control box - CPU board for ITI2012 .....	14
16 - Control box - CPU board for e-RTU2020 .....	14
17 - Control box - Fault current detection board .....	15
18 - Control box - Transformer .....	15
19 - Control box - Primary electrical protection .....	16
20 - Control box - Miscellaneous .....	17
21 - Control box - ITI2000 generation .....	18

## 1 - COMPLETE LOAD BREAK SWITCH



Ensto Ref	Product designation		Customer Ref
NXQ880016	Complete AUGUSTE LBS for 11kV network		
Type of package	Package size	Quantity of items per package	Weight
Wooden box	1620x1580x680mm	1	400kg

Ensto Ref	Product designation		Customer Ref
NXQ880015	Complete AUGUSTE LBS for 36kV network		
Type of package	Package size	Quantity of items per package	Weight
Wooden box	1620x1580x680mm	1	400kg

## 2 - SURGE ARRESTER



Ensto Ref	Product designation	Customer Ref
-----------	---------------------	--------------

NX2010695 / 72989\_00

<b>NX2010647</b>	<b>Set of 2 Surge Arresters Brackets with copper grounding</b>		
<b>Type of package</b>	<b>Package size</b>	<b>Quantity of items per package</b>	<b>Weight</b>
<b>Plastic bag</b>	<b>600x400mm</b>	<b>1</b>	<b>2kg</b>



<b>Ensto Ref</b>	<b>Product designation</b>	<b>Customer Ref</b>
<b>NX7230805</b>	<b>VARISIL HE-S 12 NO/SPEN surge arrester</b>	
<b>Type of package</b>	<b>Package size</b>	<b>Quantity of items per package</b>
<b>Cardboard box</b>	<b>152x115x248mm</b>	<b>1</b>
		<b>Weight</b>
		<b>1,9kg</b>



<b>Ensto Ref</b>	<b>Product designation</b>	<b>Customer Ref</b>
<b>NX7230821</b>	<b>VARISIL HE-S 36 NO/SPEN surge arrester</b>	
<b>Type of package</b>	<b>Package size</b>	<b>Quantity of items per package</b>
<b>Cardboard box</b>	<b>118x118x409mm</b>	<b>1</b>
		<b>Weight</b>
		<b>3,1kg</b>

### 3 - HV NETWORK CONNECTION



<b>Ensto Ref</b>	<b>Product designation</b>	<b>Customer Ref</b>
------------------	----------------------------	---------------------

<b>NX2010467</b>	<b>Kit of 6 bird protector covers</b>		
<b>Type of package</b>	<b>Package size</b>	<b>Quantity of items per package</b>	<b>Weight</b>
<b>Cardboard box</b>	<b>590x375x390mm</b>	<b>1</b>	<b>2,5kg</b>

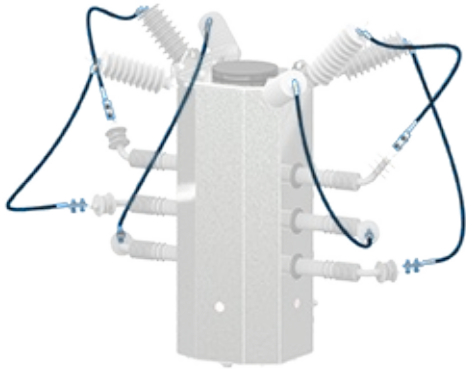

<b>Ensto Ref</b>	<b>Product designation</b>		<b>Customer Ref</b>
<b>NX2010582</b>	<b>Kit of 6 jumpers for HE-S 12 NO</b>		
<b>Type of package</b>	<b>Package size</b>	<b>Quantity of items per package</b>	<b>Weight</b>
<b>Plastic bag</b>	<b>160x1500mm</b>	<b>1</b>	<b>10kg</b>

<b>Ensto Ref</b>	<b>Product designation</b>		<b>Customer Ref</b>
<b>NX2010572</b>	<b>Kit of 6 jumpers for HE-S 36 NO</b>		
<b>Type of package</b>	<b>Package size</b>	<b>Quantity of items per package</b>	<b>Weight</b>
<b>Plastic bag</b>	<b>160x1500mm</b>	<b>1</b>	<b>10kg</b>

## 4 - SWITCH - POLE FIXING



<b>Ensto Ref</b>	<b>Product designation</b>		<b>Customer Ref</b>
<b>NX2009865</b>	<b>Conversion kit for adaptation of new brackets on old tanks</b>		
<b>Type of package</b>	<b>Package size</b>	<b>Quantity of items per package</b>	<b>Weight</b>
<b>Plastic bag</b>	<b>160x400mm</b>	<b>1</b>	<b>3kg</b>



Ensto Ref	Product designation		Customer Ref
<b>NX2010388</b>	<b>NEW Switch Pole mounting bracket including fixing kit</b>		
Type of package	Package size	Quantity of items per package	Weight
<b>Cardboard box</b>	<b>750x300x170</b>	<b>1</b>	<b>10,5kg</b>

## 5 - MOTORIZED MECHANISM

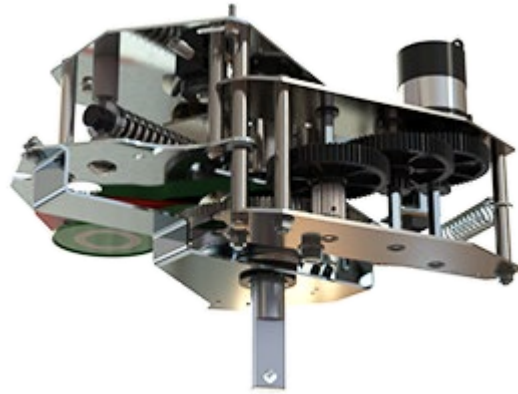
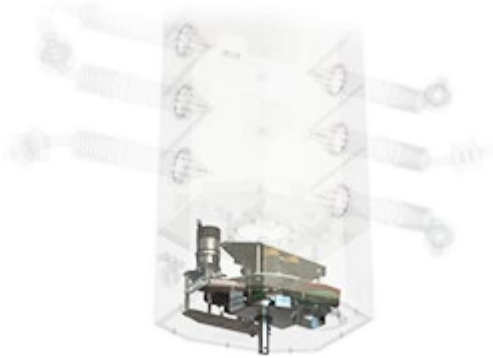

Ensto Ref	Product designation		Customer Ref
<b>NX2008402</b>	<b>Complete switchgear mechanism</b>		
Type of package	Package size	Quantity of items per package	Weight
<b>Cardboard box</b>	<b>500x400x400mm</b>	<b>1</b>	<b>14kg</b>

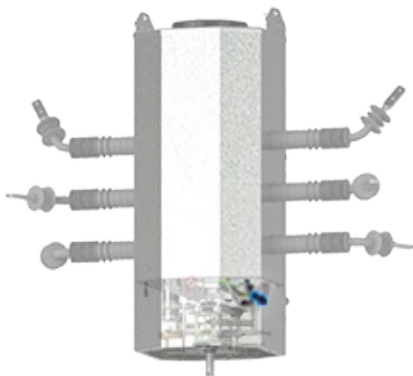

Ensto Ref	Product designation		Customer Ref
<b>NX2010646</b>	<b>Box of 10 fuses 5x20mm 6,3A</b>		
Type of package	Package size	Quantity of items per package	Weight
<b>Plastic bag</b>	<b>160x200mm</b>	<b>1</b>	<b>0,05kg</b>

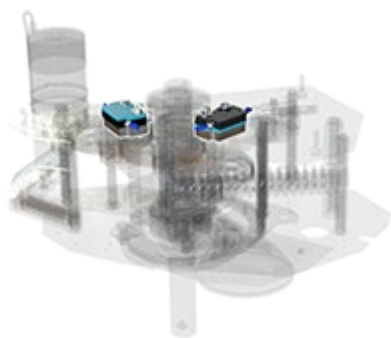

Ensto Ref	Product designation		Customer Ref
<b>NX2009881</b>	<b>Open/Closed end contact kit</b>		
Type of package	Package size	Quantity of items per package	Weight
<b>Cardboard box</b>	<b>135x105x160mm</b>	<b>1</b>	<b>0,5kg</b>



Ensto Ref	Product designation		Customer Ref
<b>NX2009979</b>	<b>Output shaft of the switchgear mechanism</b>		
Type of package	Package size	Quantity of items per package	Weight
<b>Cardboard box</b>	<b>180x170x440mm</b>	<b>1</b>	<b>2kg</b>



Ensto Ref	Product designation		Customer Ref
<b>NXC329254</b>	<b>12V switchgear motor</b>		
Type of package	Package size	Quantity of items per package	Weight
<b>Cardboard box</b>	<b>260x240x140mm</b>	<b>1</b>	<b>1kg</b>



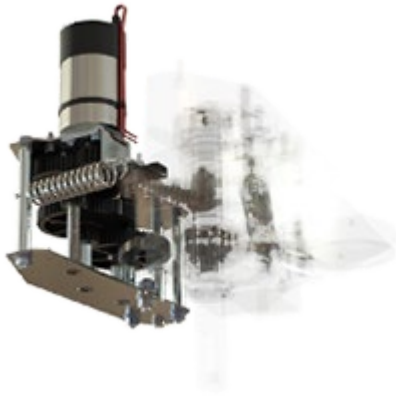

Ensto Ref	Product designation		Customer Ref
NXC329276	12V motor and gears kit		
Type of package	Package size	Quantity of items per package	Weight
Cardboard box	375x260x215mm	1	3,5kg

## 6 - LOWER COVER

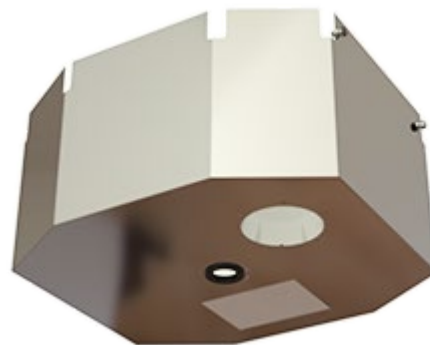

Ensto Ref	Product designation		Customer Ref
NXC329288	Mechanism protection cover		
Type of package	Package size	Quantity of items per package	Weight
Cardboard box	555x380x375mm	1	5,5kg



Ensto Ref	Product designation		Customer Ref
NXC329283	Glass window replacement kit		

NX2010695 / 72989\_00

Type of package	Package size	Quantity of items per package	Weight
Plastic bag	400x400mm	1	0,2kg

## 7 - SAFETY MANUAL COMMAND



Ensto Ref	Product designation	Customer Ref
NX2009484	Hook stick with Green/red indication including fixing kit	

Type of package	Package size	Quantity of items per package	Weight
Cardboard box	500x400x400mm	1	16kg

## 8 - OPTIONS



Ensto Ref	Product designation	Customer Ref
NXC360204	External FPI flashing light	

Type of package	Package size	Quantity of items per package	Weight
Cardboard box	260x240x140mm	1	1kg

## 9 - ACCESSORIES



Ensto Ref	Product designation		Customer Ref
<b>NX2010409</b>	<b>Handling and storage frame</b>		
Type of package	Package size	Quantity of items per package	Weight
<b>Wooden box</b>	<b>1000x800x1820mm</b>	<b>1</b>	<b>70kg</b>

## 10 - ENTIRE E-RTU CONTROL BOX FOR AUGUSTE



Ensto Ref	Product designation	Customer Ref	
NX2010721	e-RTU IEC104 control box for 11kV network		
Type of package	Package size	Quantity of items per package	Weight
Wooden box	840x465x460mm	1	18kg

## 11 - CONTROL BOX - POLE FIXING



Ensto Ref	Product designation		Customer Ref
<b>NX2010395</b>	<b>Control box mounting bracket including fixing kit</b>		
Type of package	Package size	Quantity of items per package	Weight
<b>Cardboard box</b>	<b>510x320x180mm</b>	<b>1</b>	<b>3,5kg</b>

## 12 - CONTROL BOX - BACKPLANE BOARD

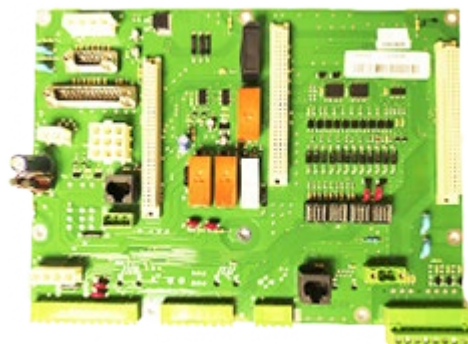

Ensto Ref	Product designation		Customer Ref
<b>NX2008925</b>	<b>Backplane board packed</b>		
Type of package	Package size	Quantity of items per package	Weight
<b>Cardboard box with foam</b>	<b>350x280x80mm</b>	<b>1</b>	<b>0,7kg</b>

## 13 - CONTROL BOX - DISPLAY BOARD



Ensto Ref	Product designation		Customer Ref
<b>NX2007202</b>	<b>Display board packed</b>		
Type of package	Package size	Quantity of items per package	Weight
<b>Cardboard box with foam</b>	<b>240x180x50mm</b>	<b>1</b>	<b>0,4kg</b>

## 14 - CONTROL BOARD - CHARGER BOARD

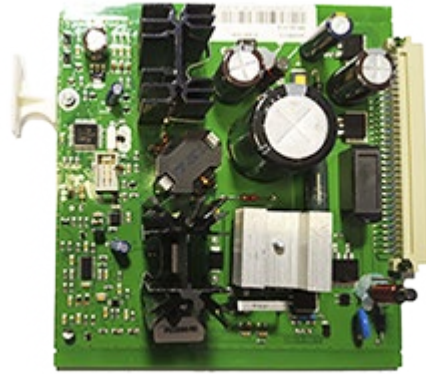

Ensto Ref	Product designation		Customer Ref
<b>NX2007205</b>	<b>12V charger board packed</b>		
Type of package	Package size	Quantity of items per package	Weight
<b>Cardboard box with foam</b>	<b>350x280x80mm</b>	<b>1</b>	<b>0,7kg</b>

## 15 - CONTROL BOX - CPU BOARD FOR ITI2012



Ensto Ref	Product designation		Customer Ref
<b>NX2007224</b>	<b>ITI2012 CPU board DNP3 protocol packed</b>		
Type of package	Package size	Quantity of items per package	Weight
<b>Cardboard box with foam</b>	<b>350x280x80mm</b>	<b>1</b>	<b>0,8kg</b>

## 16 - CONTROL BOX - CPU BOARD FOR E-RTU2020



Ensto Ref	Product designation		Customer Ref
<b>NX2010480</b>	<b>e-RTU2020 CPU board IEC104 protocol packed</b>		

**NX2010695 / 72989\_00**

Type of package	Package size	Quantity of items per package	Weight
Cardboard box with foam	350x280x80mm	1	1kg

## 17 - CONTROL BOX - FAULT CURRENT DETECTION BOARD

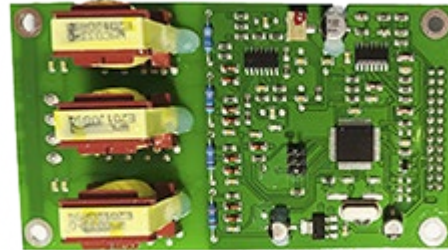
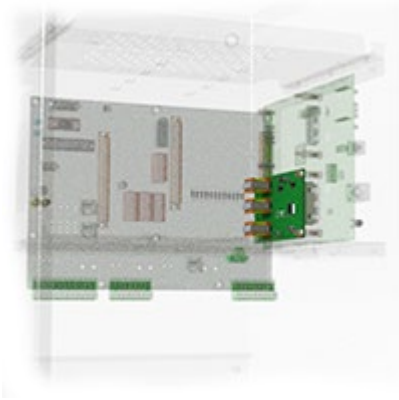

Ensto Ref	Product designation		Customer Ref
NX2007212	Fault detection board (3phase CTs Ratio 500/1) packed		
Type of package	Package size	Quantity of items per package	Weight
Cardboard box with foam	240x180x50mm	1	0,2kg

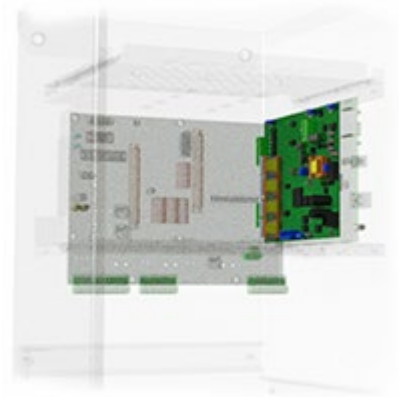

Ensto Ref	Product designation		Customer Ref
NX2010702	Measurement board (3phase CTs 5P20) packed		
Type of package	Package size	Quantity of items per package	Weight
Cardboard box with foam	350x280x80mm	1	1kg

## 18 - CONTROL BOX - TRANSFORMER



Ensto Ref	Product designation		Customer Ref
NX2009993	ITI2012 Transformer 101-135-230V/27V		
Type of package	Package size	Quantity of items per package	Weight
Cardboard box	175X130X120mm	1	2kg

## 19 - CONTROL BOX - PRIMARY ELECTRICAL PROTECTION



Ensto Ref	Product designation		Customer Ref
NX2010644	Box of 10 fuses 10x38 2A gG		
Type of package	Package size	Quantity of items per package	Weight
Plastic bag	160x200mm	1	0,08kg



Ensto Ref	Product designation		Customer Ref
NX2010184	PMD20-230 Lighting protector		



Type of package	Package size	Quantity of items per package	Weight
Plastic bag	160x200mm	1	0,25kg



Ensto Ref	Product designation	Customer Ref
NX2010646	Box of 10 fuses 5x20mm 6,3A	

Type of package	Package size	Quantity of items per package	Weight
Plastic bag	160x200mm	1	0,05kg

## 20 - CONTROL BOX - MISCELLANEOUS



Ensto Ref	Product designation	Customer Ref
NXC360161	Battery connecting harness for 12V control box	

Type of package	Package size	Quantity of items per package	Weight
Plastic bag	160x200mm	1	0,1kg

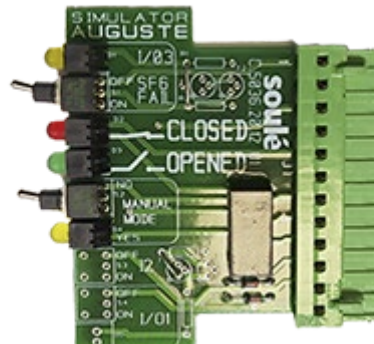

Ensto Ref	Product designation	Customer Ref
-----------	---------------------	--------------

NX2006397	Commissioning kit (simulator and 5m length Ethernet cable)		
Type of package	Package size	Quantity of items per package	Weight
Cardboard box	230x160x80	1	0,4kg

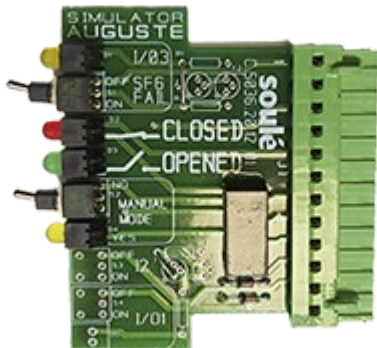

Ensto Ref	Product designation	Customer Ref
NXC360075	Complete simulator	
Type of package	Package size	Quantity of items per package
Plastic briefcase	135x94x31mm	1
		Weight
		0,2kg



Ensto Ref	Product designation	Customer Ref
NX2009591	VISIO II current injection case	
Type of package	Package size	Quantity of items per package
Cardboard box	510x320x180mm	1
		Weight
		8,2kg

## 21 - CONTROL BOX - ITI2000 GENERATION

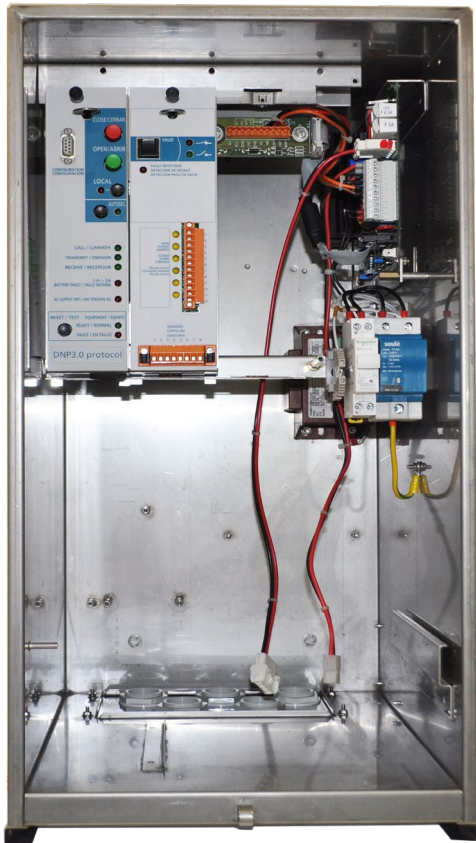

Ensto Novexia customer service department is always able to offer you the spare parts that will allow you to maintain functional your control box fleet reference NXC5036/serial number/year.

Other spare parts are also available (contact us).

Ensto Novexia customer service also offers you the expertise, repair, hardware and software update of this generation of control box and all its electronic cards.

**Give a second life to your control boxes.**



Ensto Ref	Product designation		Customer Ref
NXC361218	Pole mounting bracket for ITI2000 generation control box		
Type of package	Package size	Quantity of items per package	Weight
Plastic bag	400x500mm	1	4kg



Ensto Ref	Product designation	Customer Ref	
NXC361225	Bottom plate with packing glands kit		
Type of package	Package size	Quantity of items per package	Weight
Plastic bag	400x500mm	1	1kg



Ensto Ref	Product designation	Customer Ref	
NXC360048	12V charger board packed		
Type of package	Package size	Quantity of items per package	Weight
Cardboard box with foam	280x180x80mm	1	0,7kg

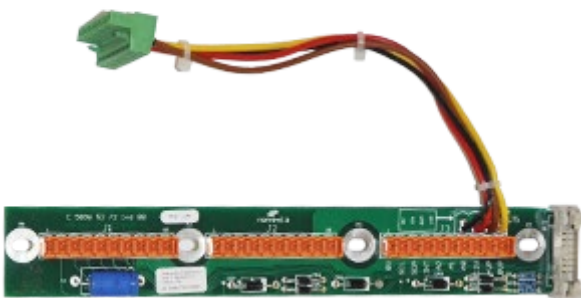

Ensto Ref	Product designation	Customer Ref	
NXC360142	2 ways backplane packed		
Type of package	Package size	Quantity of items per package	Weight
Plastic bag	160x300mm	1	0,2kg



Ensto Ref	Product designation		Customer Ref
NXC360156	CPU board DNP3 protocol packed		
Type of package	Package size	Quantity of items per package	Weight
Cardboard box with foam	280x180x80mm	1	0,6kg



Ensto Ref	Product designation		Customer Ref
NXC360186	Secured Electrical control module with fault detection board (3CTs : 3 phase)		
Type of package	Package size	Quantity of items per package	Weight
Cardboard box with foam	350x280x80mm	1	1,4kg



Ensto Ref	Product designation	Customer Ref
NX2010427	ITI2000 Transformer 115-172-230V/17V	

Type of package	Package size	Quantity of items per package	Weight
Cardboard box	175X130X120mm	1	2kg

# Notes

.....

.....

.....

.....

.....

.....

.....

.....

.....

.....

.....

.....

.....

.....

.....

.....

.....

.....

.....

.....

.....

.....

.....

.....

.....

.....

.....

.....

.....

.....

.....

.....

.....

.....

.....

.....

.....

.....

.....

.....

.....

.....

.....

.....

.....

.....

.....

.....

.....

.....

.....



## Material tracking sheet

### **After Sales Service**

*Parc d'Activités de la Haute-Bigorre*

*Boulevard de l'Adour*

*65200 Bagnères de Bigorre*

*Fixe : +33 (0)5 62 91 45 10*

*Mobile : +33 (0)6 70 00 71 99*

Ce document est la propriété de la société Ensto Novexia, il ne peut être ni reproduit, ni communiqué à des tiers sans autorisation écrite

This document is the property of Ensto NOVEXIA; it may not be reproduced, disclosed without written authorization

## General

### - Before unpacking

- > Verify that the product in its packaging has not been damaged during transport.
- > Verify that the product is suitable for the intended installation.

### - Before installation

- > Carefully read the operation guide before installing or using this product.
- > Perform the installation carefully, ensuring that the equipment remains clean throughout the operation.

### - After installation

- > If you are installing this product for someone else, leave the guide for the end user.
- > Clean the work area after installation.

## Legal notices

The product may only be installed by a competent person with adequate training in the installation practices and with adequate knowledge of proper safety and installation practices for electrical equipment. If local regulations have requirements relating to this training or adequate knowledge in terms of the installation of electrical equipment, the aforementioned requirements must be complied with by this person.

Ensto Novexia will not be held responsible in any way for damage to property or persons caused by an incorrect installation, incorrect operation or lack of compliance with the safety instructions.

### **WARNING:**

For the operation of this system in complete safety, it is essential that the installers, users and technicians follow the procedures and precautions described in this guide. Non-compliance with these instructions may cause damage to the products and/or serious or even mortal injury.





# ENSTO

**Ensto Novexia SAS**  
210, rue Léon Jouhaux - BP 10446  
FR - 69656 Villefranche-sur-Saône cedex, France  
Tel: +33 (0)4 74 65 61 61  
Fax: +33 (0)4 74 62 96 57  
Email: [infos.novexia@ensto.com](mailto:infos.novexia@ensto.com)

[ensto.com](http://ensto.com)

