

ENSTO

Ensto Surge Arresters

Effective protection of electrical networks against overvoltages



Better life.
With electricity.

Ensto designs and provides smart electrical solutions to improve the safety, functionality, reliability and efficiency of smart grids, buildings and transportation.

ensto.com



Ensto surge arresters

The best solutions for a customer's expectation

Product strengths

- Guaranteed continuity of service
- Improved power quality
- Guaranteed personal and equipment safety
- Maintenance-free equipment

In order to provide good-quality energy, utilities must constantly improve the quality of their grids; in this challenge, overvoltage protection is a key element.

Appropriate overvoltage protection is fundamental in optimising the continuity of service; furthermore, it ensures personal safety and reduces immobilization costs.

A surge arrester for every application

Designed and manufactured to the highest quality standards, Ensto's range of surge arresters ensures years of maintenance-free service in the following fields:

- Overvoltage protection for HV and MV networks
- Overvoltage protection for railway networks, either in direct or alternating current

- Overvoltage protection for cable sheathes
- Voltage limitation for non-earthed metal structures

Based on metal oxide varistor and silicone rubber technologies, our surge arresters provide total control of residual voltage based on insulation coordination rules, thus considerably improving the level of protection.

Surge arresters for railway applications

The availability of a secure railway power supply is critical for operators. This search for reliability requires, amongst others, the use of specific surge arresters and voltage limiters suitable to these networks. The protection afforded by these devices ensures the safety of people and equipment, thus reducing operating costs.

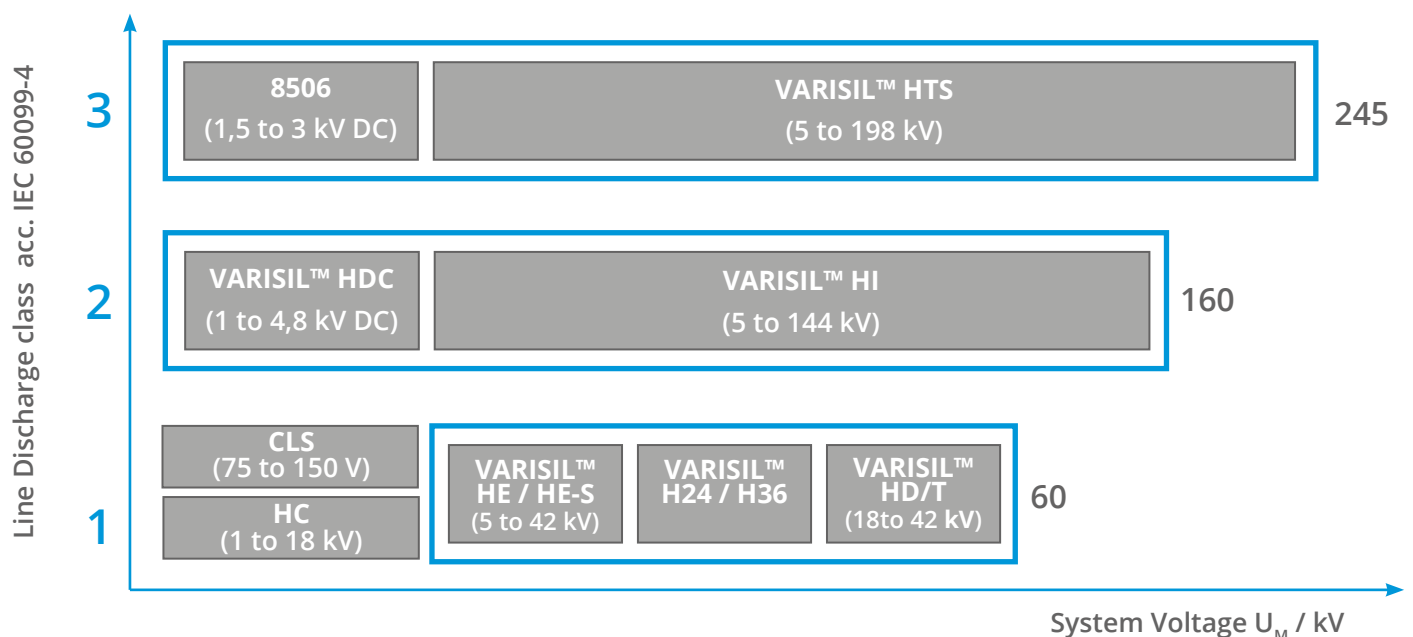

Our range of products

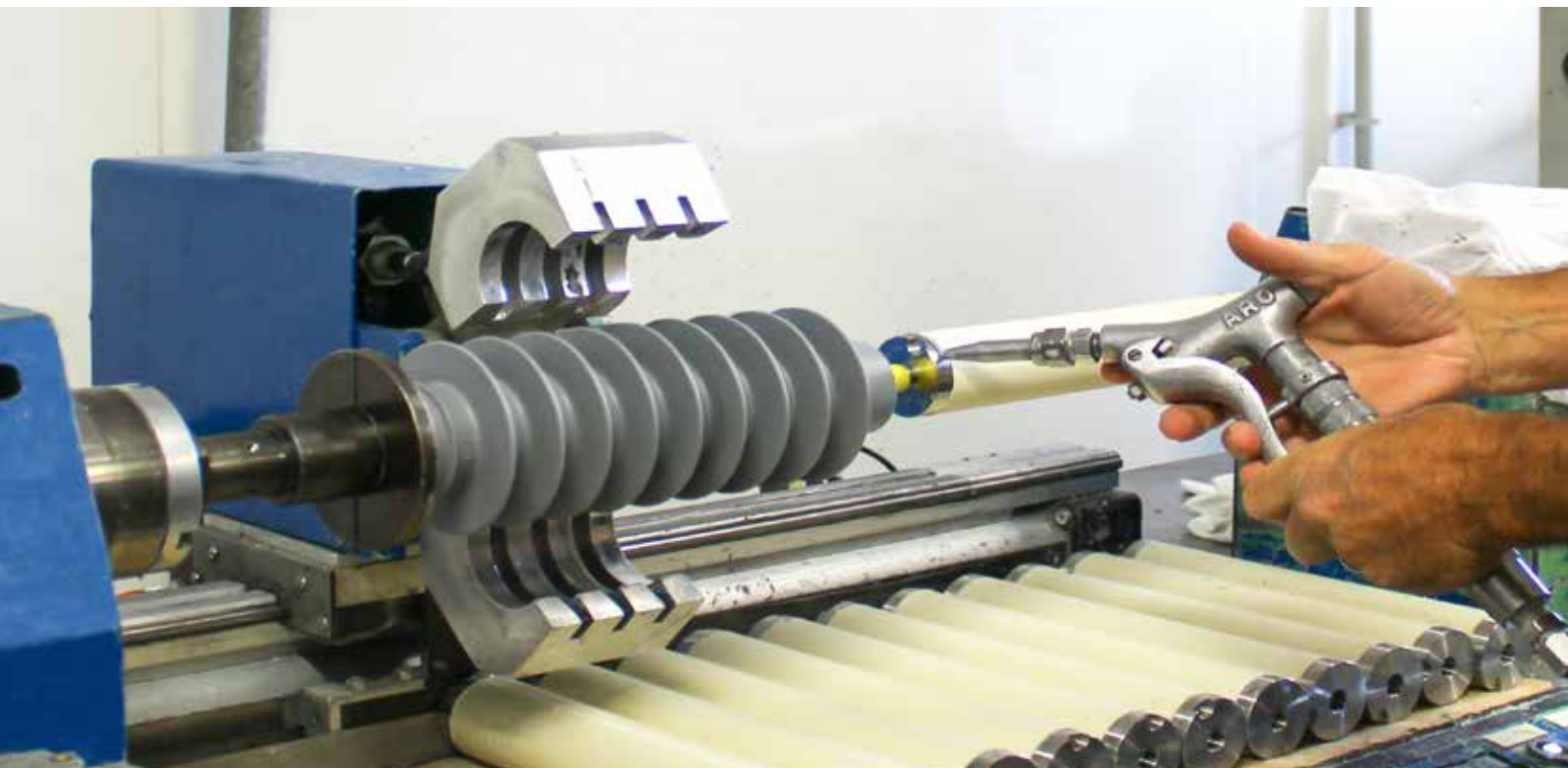

Distribution Surge Arresters		
Class 1 / DH	VARISIL™ HE	5 to 36 kV
Class 1 / DH	VARISIL™ HE-S	5 to 54 kV
Class 1 / DH	VARISIL™ H24 / H36	24 and 36 kV
Station Class Surge Arresters		
Class 2 / SL	VARISIL™ HI	5 to 144 kV
Class 3 / SM	VARISIL™ HTS	5 to 204 kV
Railway Surge Arresters		
Class 1 / DH	VARISIL™ HD / T	18 to 42 kV
Class 2 / SL	VARISIL™ HDC	1 000 to 4 800 Vdc
Class 3 / SM	8506	2 000 Vdc & 4 000 Vdc
Voltage Limiters		
N.A.	CLS	75 to 150 Vac or Vdc
Sheath Voltage Limiters		
Class 1 / DH	VARISIL™ HC	5 to 18 kV
Class 1 / DH	RNL HC	1 to 6 kV



With more than 70 years of experience in overvoltage protection, Ensto offers products and solutions which substantially contribute to the improvement of quality, reliability and availability of power supply networks.

More than 5 million VARISIL™ surge arresters are now in service all over the world.

Ensto has been selling its own polymer housed metal oxide surge arresters for more than 25 years under the VARISIL™ trademark. VARISIL™ surge arresters can capitalize on long and proven field experience. In particular, they have demonstrated their ability to operate durably even in the harshest environmental conditions.

Ensto products are manufactured with high-quality raw materials and components, whose conformity and characteristics are highly checked and controlled.

VARISIL™ surge arresters have been designed with respect to sustainable development, by limiting consumption of resources at the manufacturing stages and for easier dismantling at the end of life.

Optimized and eco-friendly design

VARISIL™ surge arresters are built with high-energy Metal Oxide Varistors (MOV), being housed by HTV silicone rubber, and finally encapsulating into a fiberglass-reinforced solid core. Using raw materials with outstanding electrical and mechanical properties allow us to make the products more compact, thus saving global resources and limiting waste.

If needed, the various constituents can be separated rather easily and quickly for end-of-life management and disposal.

Compliance with international standards

Ensto products are designed and manufactured with a Quality Management System certified to ISO 9001 and based on the latest edition published in 2015.

In addition, all VARISIL™ surge arresters fulfill the requirements of IEC 60099-4, including the new classification introduced in 2014 and the associated performance levels. Type testing and routine testing are carried out accordingly.



Distribution Surge Arresters

VARISIL™ HE and HE-S



These ranges of surge arresters are dedicated to overvoltage protection of Distribution networks up to 36 kV for VARISIL™ HE and up to 52 kV for VARISIL™ HE-S. According to IEC 60099 edition 2014, these products belong to the Distribution Heavy (DH) classification.

VARISIL™ HE and HE-S are polymer housed gapless surge arresters. The metal oxide varistor blocks are wrapped by a fiberglass-reinforced epoxy resin, encapsulated in a silicone rubber housing. The HE-S is made of more layers of wrapping to ensure strength. The design of the VARISIL™ HE-S provides double cantilever strength.

Customer Benefits

- High resistance to climatic stresses
- Optimized electrical performance
- Long creepage distance



Typical design for Distribution Surge Arrester

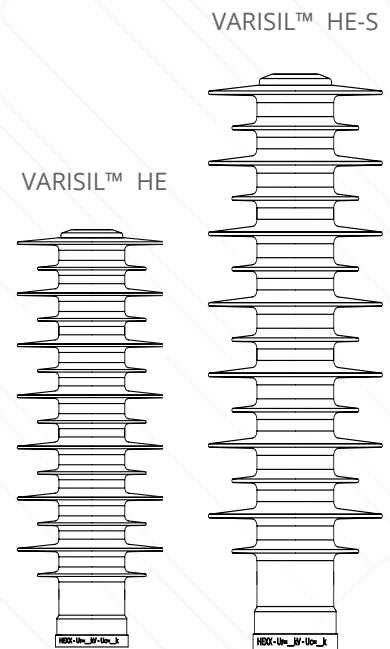
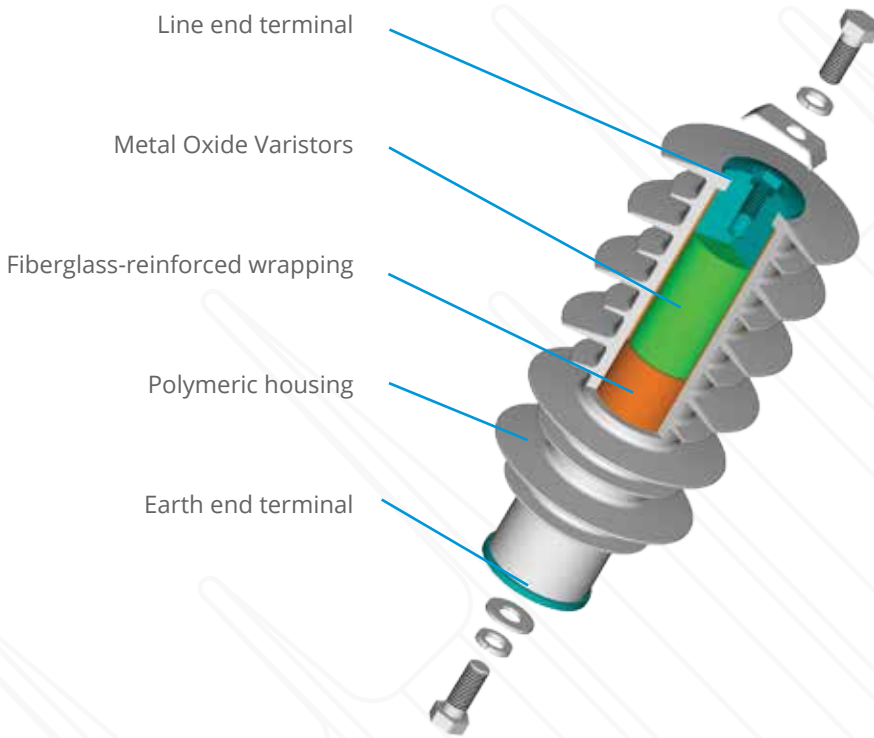

OPTIONS

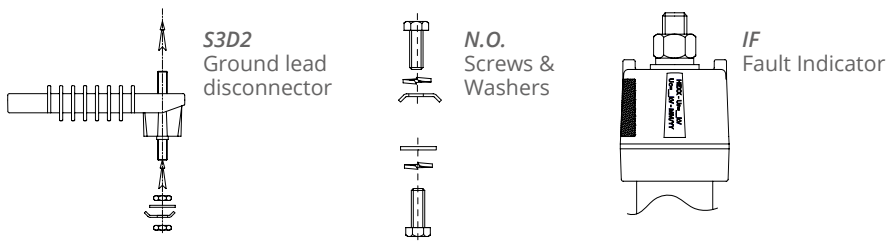

ACCESSORIES

Mounting bracket for cross arm, earth braid, pedestal (insulated or not).

TECHNICAL CHARACTERISTICS	VARISIL™ HE	VARISIL™ HE-S
Rated Voltage (Ur)	5 to 36 kV rms	5 to 54 kV rms
Nominal discharge current (In)	10 kA with 8/20 waveshape	10 kA with 8/20 waveshape
Line discharge class / Classification	1 / DH	1 / DH
High current impulse withstand	100 kA with 4/10 waveshape	100 kA with 4/10 waveshape
Long duration current impulse withstand	300 A with 2 000 µs waveshape	300 A with 2 000 µs waveshape
Energy absorption capability (with 8/20 waveshape)	4.8 kJ/kV of Uc	4.8 kJ/kV of Uc
Specified long-term load	10 daN.m	20 daN.m
Short circuit current withstand	20 kA/0.2s - 600 A/1s	20 kA/0.2s - 600 A/1s

(*) For high mechanical performance refer to our VARISIL™ HE-S or HI products



The MOV have the property of shifting very rapidly from an insulating state to a very conductive state when voltage, at their terminals, increases.

Under normal conditions, the leakage current is very low and mainly capacitive. As a result, it is not necessary to use series gaps with MOV.

When the line is subjected to a transient overvoltage, the surge arrester operates instantaneously, a preferred path for the energy to the earth.

This avoids potentially dangerous voltage stress to electrical equipment.



Distribution Surge Arresters

VARISIL™ H24 and H36

VARISIL™ H24 and H36 are dedicated for Distribution networks in accordance with the HN 65-S-40 standard (EDF) and IEC 60099-4 edition 2014.

These surge arresters are equipped with a fault indicator based on electronic detection. VARISIL™ H24 and H36 are polymer-housed gapless surge arresters.



Customer Benefits

- Compact size
- High mechanical strength
- High sensitivity of the fault indicator

OPTION INTEGRATED

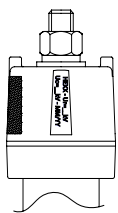

IF
Fault Indicator

ACCESSORIES

The product can be associated with various connection accessories (fittings, connectors) depending on the installation conditions: horizontal mounting on transformer (H61) or on a riser pole (ERAS), vertical mounting (hanging mode).

TECHNICAL CHARACTERISTICS

	H24	H36
Rated Voltage (Ur)	24	36
Continuous operating voltage (kV rms)	12.7	20.8
Nominal discharge current (kA 8/20)	5	5
Maximum residual voltage at 5 kA 8/20 (kV peak)	75	105
Maximum residual voltage at 40 kA 8/20 (kV peak)	100	140
High-current impulse withstand (kA 4/10)	100	100
Long-duration current impulse withstand (A 2 000 μs)	300	300
Short-circuit current withstand (kA rms/3.7s)	6	6
Sensibility of the fault indicator (A rms/0.5s)	10	10
Nominal creepage distance (mm)	600	900
Diameter of the weathersheds (mm)	99	106
Overall height (mm)	405	485
Approximate weight (kg)	3.8	4.8
Specified long-term load	30 daN.m	30 daN.m

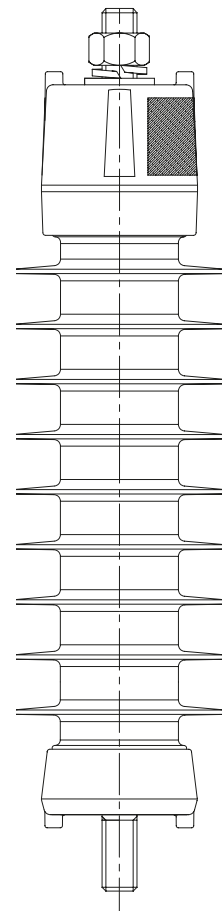

Station Class Surge Arresters

VARISIL™ HI and HTS

These ranges of surge arresters are dedicated for substations and/or power transformers for networks up to 170 kV for HI range and up to 245 kV for HTS range.

According to IEC 60099-4 edition 2014, VARISIL™ HI belongs to SL classification and VARISIL™ HTS belongs to SM classification.

These products are suitable for utilities, industries and contractors.

VARISIL™ HI and HTS are polymer-housed gapless surge arresters.

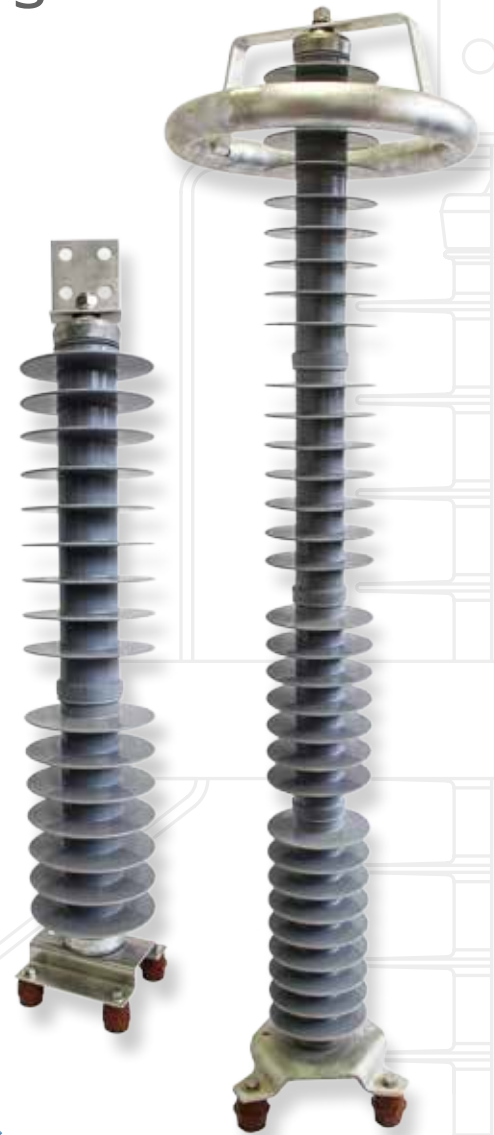

Customer Benefits

- High electrical performance
- Safe overvoltage protection
- Adjustable creepage distance
- Short delivery time

VARISIL™ HI
From 1 to 4 units

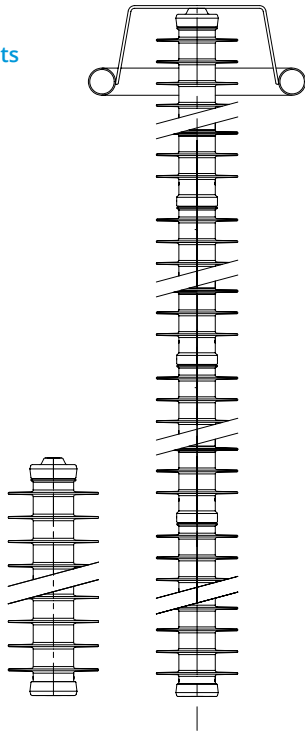

VARISIL™ HTS
From 1 to 5 units

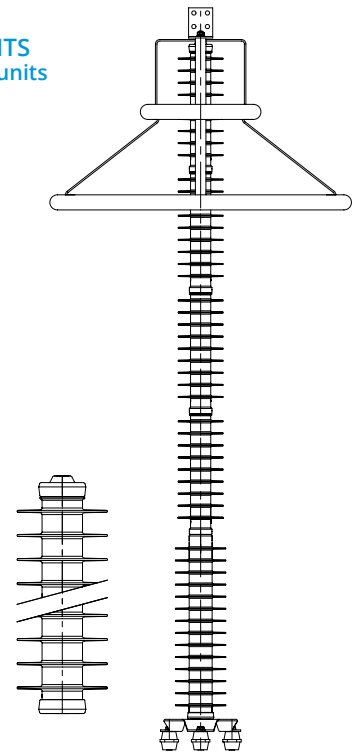

LINE TERMINAL OPTIONS

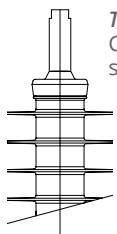

TC
Cylindrical stem

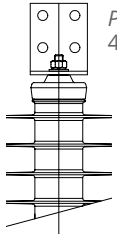

PE
4-hole pad

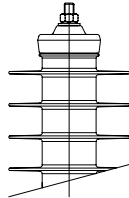

TF
M12 stud

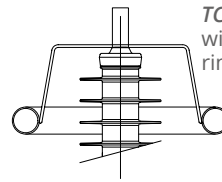

TC
with grating ring

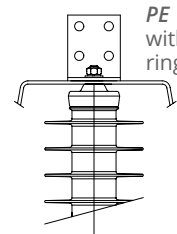

PE
with grating ring

EARTH TERMINAL OPTIONS



TF
M12 stud

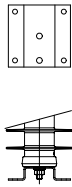

SC
Square pedestal

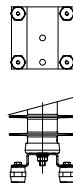

SCI
Insulated square pedestal

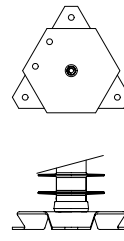

ST
Tripod pedestal

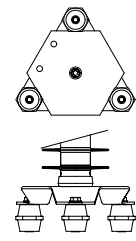

STI
Insulated tripod pedestal

ACCESSORIES

Discharge counter : MDC3

TECHNICAL CHARACTERISTICS	VARISIL™ HI	VARISIL™ HTS
Rated Voltage (Ur)	5 to 144 kV rms	5 to 204 kV rms
Nominal discharge current (In)	10 kA with 8/20 waveshape	10 kA with 8/20 waveshape
Line discharge class / Classification	2 / SL	3 / SM
High-current impulse withstand	100 kA with 4/10 waveshape	100 kA with 4/10 waveshape
Long-duration current impulse withstand	500 A with 2 000 μs waveshape	800 A with 2 000 μs waveshape
Specified long-term load	80 daN.m	80 daN.m
Short-circuit current withstand	63 kA/0.2s	63 kA/0.2s





Railway Surge Arresters

VARISIL™ HD/T

This range of surge arresters is dedicated for a.c. railway installations. According to IEC 60099-4, VARISIL™ HD/T belongs to Line Discharge Class 1/ Distribution Heavy. The product is intended for railway utilities, railway OEM's and train manufacturers.

VARISIL™ HD/T is a polymer housed gapless surge arrester for overvoltage protection of equipment in substations, or on vehicles energized by alternating current. Its fiberglass-reinforced resin structure provides high withstand to shock and vibration stresses.



Customer Benefits

- Long service life
- Resistance in severe environments
- High mechanical strength

TECHNICAL CHARACTERISTICS	HD 18 / T	HD 30 / T	HD 36 / T	HD 42 / T
Single phase power system features :				
- Nominal system voltage (kV rms)	12	15	25	25
- Maximum system voltage (kV rms)	13.5	17.5	27.5	27.5
- Exceptional system voltage (kV rms)	15	24	29	33
- Rated frequency (Hz)	16.7 to 60	16.7 to 60	16.7 to 60	16.7 to 60
Rated voltage (kV rms)	18	30	36	42
Continuous operating voltage (kV rms)	15	24	29	33
Nominal discharge current (kA 8/20)	10	10	10	10
Line discharge class / Classification	1 / DH	1 / DH	1 / DH	1 / DH
Maximum lightning residual voltage at 10 kA 8/20 (kV peak)	51	84	100	114.5
High-current impulse withstand (kA 4/10)	100	100	100	100
Long-duration current impulse withstand (A 2 000 μs)	300	300	300	300
Maximum steep-current residual voltage at 10 kA 1/2.5 (kV peak)	55	90.5	107.5	123
Maximum switching residual voltage at 500 A 30/80 (kV peak)	40	66	78.5	90
Energy-absorption capability (kJ/kV rated)	2	2	2	2
Short-circuit current withstand (kA rmd/0.2s)	31.5	31.5	31.5	31.5
1-min wet power frequency withstand voltage of the housing (kV rms)	75	105	105	105
Dry lightning impulse withstand voltage of the housing (kV 1.2/50)	180	215	215	215
Nominal creepage distance (mm)	610	910	910	910
Specified long-term load (daN.m)	30	30	30	30

Railway Surge Arresters

VARISIL™ HDC

This range of surge arresters is dedicated for d.c. tramways and railway installations. According to IEC 60099-4, VARISIL™ HDC belongs to Line Discharge Class 2 / Station Low.

The product is intended for railway utilities, railway OEM's and train manufacturers.

VARISIL™ HDC is a polymer-housed gapless surge arrester for overvoltage protection of equipment in substations, or on vehicles energized by direct current.

Its fiberglass-reinforced resin structure provides high withstand to shock and vibration stresses.

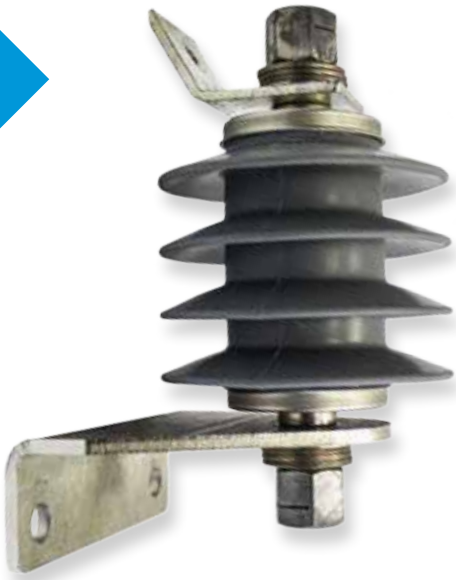

OPTIONS

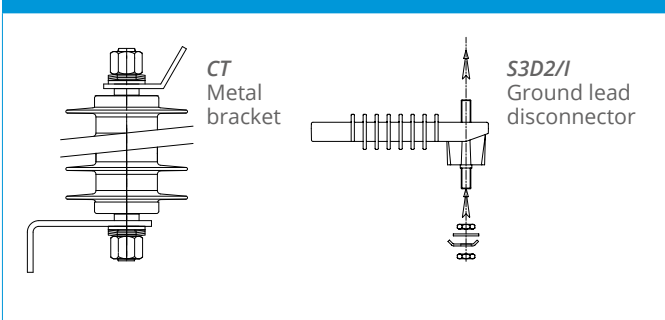

TECHNICAL CHARACTERISTICS	HDC 1	HDC 1.4	HDC 2	HDC 2.4	HDC 4	HDC 4.8
System voltage						
Maximum continuous value (Vd.c.)	900	1 250	1 800	2 200	3 600	4 400
5-min temporary value (Vd.c.)	1 000	1 400	2 000	2 400	4 000	4 800
Continuous operating voltage U _c (Vd.c.)	900	1 250	1 800	2 200	3 600	4 400
Rated voltage U _r (Vd.c.)	1 000	1 400	2 000	2 400	4 000	4 800
Nominal discharge current (kA 8/20)	10	10	10	10	10	10
High-current impulse withstand (kA 4/10)	100	100	100	100	100	100
Long-duration current impulse withstand (A 2 000 μs)	500	500	500	500	500	500
Maximum lightning residual voltage at I _n (protection level, V peak)	3 000	4 200	6 000	7 200	12 000	14 400
Maximum switching residual voltage at 500A with 30/80 waveshape (V peak)	2 400	3 400	4 800	5 800	9 600	11 500
Energy-absorption capability under 2 000 μs impulse (KJ/kV)	3	3	3	3	3	3
Nominal creepage distance (mm)	265	270	275	280	340	345



Railway Surge Arrester

8506

This range of surge arresters is dedicated for railway equipment connected to 1500 V d.c. and 3000 V d.c. systems.

According to IEC 60099-4, the 8506 range belongs to Line Discharge Class 3/Station Medium.

These products are intended for Railway utilities and are recommended for rolling stock.

The metal oxide varistors are connected with a series air gap inside a metal enclosure.

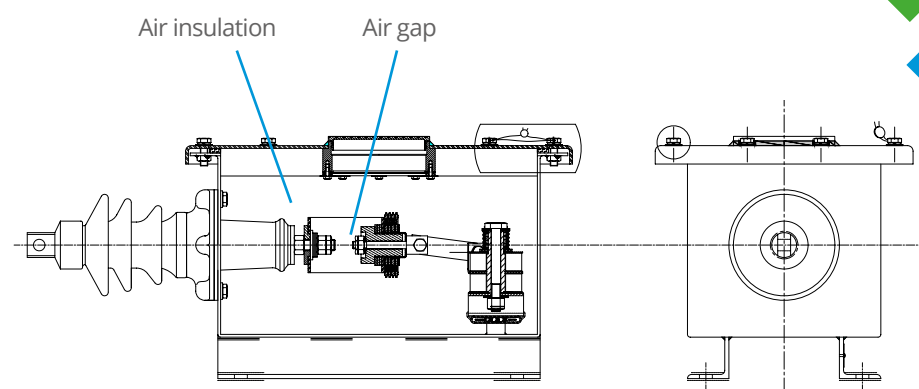

Customer Benefits

- Field-proven performance and reliability
- High safety level

TECHNICAL CHARACTERISTICS	8506-15	8506-30
DC system features :		
Nominal system voltage (Vd.c.)	1 500	3 000
Maximum system voltage (Vd.c.)	1 800	3 600
Exceptional system voltage (Vd.c.)	2 000	4 000
Rated voltage (Vd.c.)	2 000	4 000
Nominal discharge current (kA 8/20)	10	10
Minimum power frequency sparkover voltage (V rms)	2 700	4 600
Maximum lightning impulse sparkover voltage (V 1.2/50)	7 000	10 000
Maximum lightning residual voltage at 10 kA 8/20 (V peak)	6 000	12 000
Energy-absorption capability (kJ/kV rated)	4	4
Long-duration current impulse withstand (A 2 000 μs)	800	800
High-current impulse withstand (kA 4/10)	100	100
Maximum steep current residual voltage at 10 kA 1/2.5 (V peak)	6 200	12 400
Maximum switching residual voltage at 1 kA 30/80 (V peak)	5 200	10 400

Low Voltage Limiter

CLS



This range of surge arresters is dedicated for protection of people against hazardous potential rises on unearthed structures. The product is intended for either a.c. or d.c. systems operated by railway companies and railway OEM's.

The device is based on the specific electrical properties of silicon carbide.

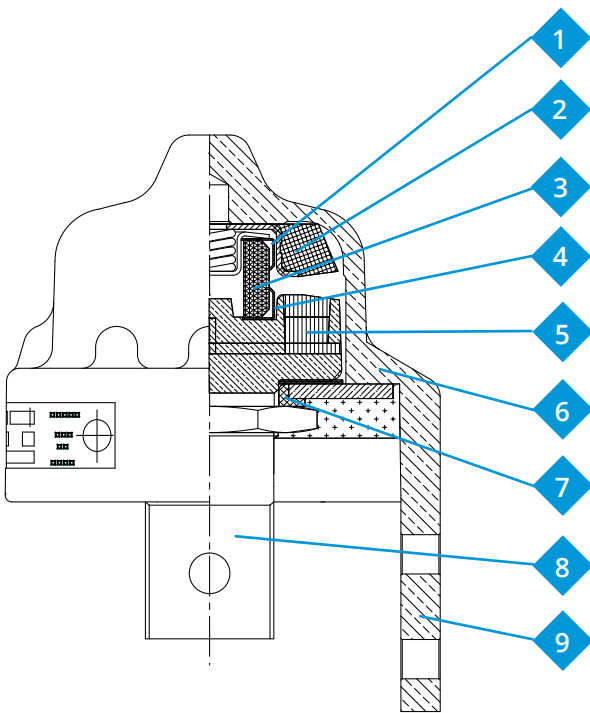

Customer Benefits

- More than 50 years proven experience in railway installations
- Proven performance
- Safety for people

- | | |
|-----------------------------|----------------------|
| 1- Electrode | 6- Brass enclosure |
| 2- Transfer electrode | 7- Insulating spacer |
| 3- Silicon carbide varistor | 8- Center electrode |
| 4- Electrode | 9- Side electrode |
| 5- Transfer electrode | |

TECHNICAL CHARACTERISTICS	1 RAY	1 RBY	1 RBCC	1 RCY	2 RAY	2 RBY	2 REY
Working voltage (V)	75 a.c.	150 a.c.	150 d.c.	50 d.c.	50 d.c.	150 d.c.	75 a.c.
Withstand voltage (V)	150 a.c.	300 a.c.	400 d.c.	150 d.c.	150 d.c.	300 d.c.	150 a.c.
Maximum sparkover voltage (V)	220 a.c.	400 a.c.	550 d.c.	250 d.c.	250 d.c.	400 d.c.	220 a.c.
Maximum leakage current under working voltage (mA)	50	50	50	50	50	50	50
Short-duration flow capability (A/s)	3 500 / 0.2	3 500 / 0.2	3 500 / 0.2	3 500 / 0.3	8 000 / 0.2	8 000 / 0.3	8 000 / 0.3
Continuous flow capability (A/30 min)	1 000	1 000	1 000	1 000	4 000	4 000	4 000

Sheath Voltage Limiter

VARISIL™ HC and RNL HC

These ranges of surge arresters are dedicated for Power Distribution or Power Transmission cable sheaths.

Two ranges of products are available:

- VARISIL™ HC is a polymer-housed gapless surge arrester for single-point bonded sections
- RNL HC is a plastic overmoulding gapless surge arrester for use inside cross-bonding cabinets

According to IEC 60099-4, VARISIL™ HC and RNL HC belong to Line Discharge Class 1/ Distribution Heavy. The products are intended for utilities and cable manufacturers.



VARISIL™ HC



RNL HC 1



RNL HC 2



RNL HC 3



RNL HC 6

Plastic overmoulding

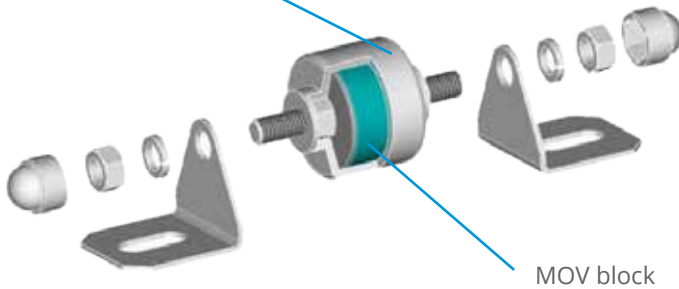

MOV block

Customer Benefits

- Increased cable longevity
- Proven experience

OPTIONS

VARISIL™ HC

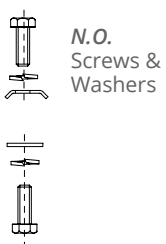

N.O.
Screws &
Washers

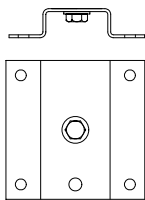

P2
Square
pedestal

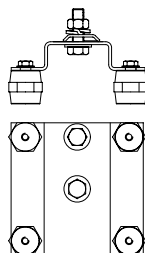

IP2
Insulated P2

RNL HC



Symmetrical
metal
brackets
B0/B1/B2



Asymmetrical
metal
brackets
B3

TECHNICAL CHARACTERISTICS VARISIL™ HC	HC05	HC06	HC10	HC12	HC15	HC18
Rated voltage U_r (kV rms)	5	6	10	12	15	18
Continuous operating voltage U_c (kV rms)	4	4.8	8	9.6	12	14.4
Nominal discharge current I_n (kA 8/20)	10	10	10	10	10	10
High-current impulse withstand (kA 4/10)	100	100	100	100	100	100
Long-duration current impulse withstand (A 2 000 μ s)	300	300	300	300	300	300
Short-circuit withstand (kA eff/0.2s)	31.5	31.5	31.5	31.5	31.5	31.5
Maximum residual voltage at I_n	14	16.8	28	34	42	51
Nominal creepage distance (mm)	380	220	380	380	380	380

VARISIL™ HC for single-point earthing layout

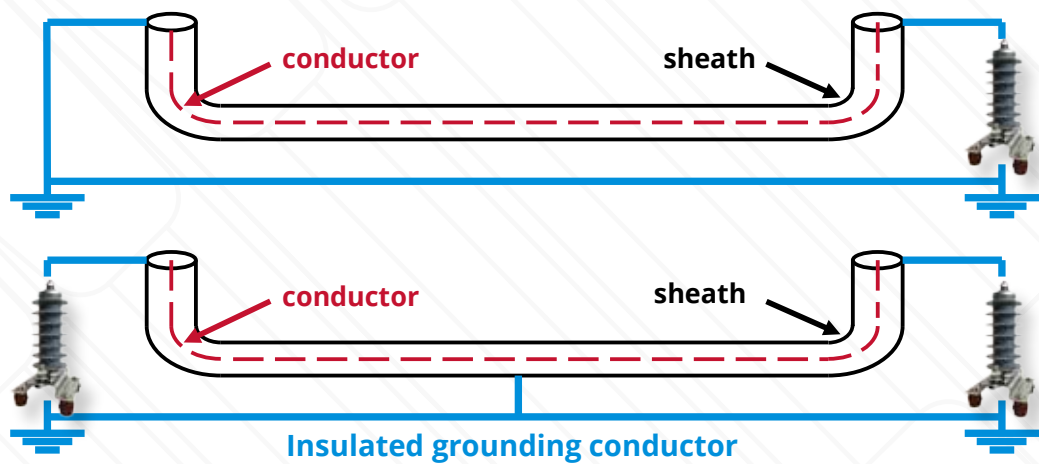

TECHNICAL CHARACTERISTICS RNL HC	HC1	HC2	HC3	HC6
Rated voltage U_r (kV rms)	1	2	3.3	6
Continuous operating voltage U_c (kV rms)	0.8	1.6	2.7	4.8
Nominal discharge current I_n (kA 8/20)	10	10	10	10
High-current impulse withstand (kA 4/10)	65	65	65	65
Long-duration current impulse withstand (A 2 000 μ s)	150	150	150	150
Maximum residual voltage at 10kA 8/20	3	6	10	18

RNL HC for cross-bonding layout

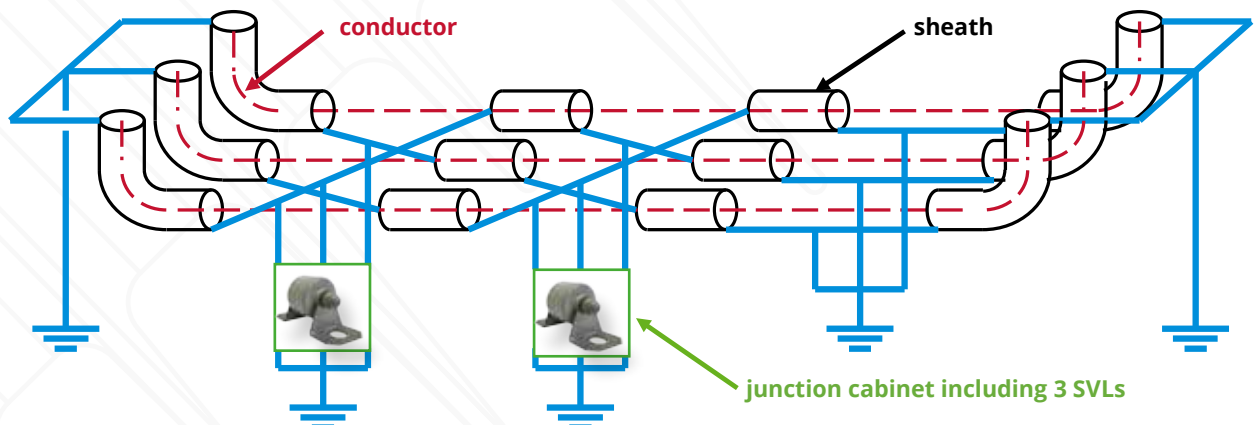

Dedicated accessories for various requirements

S3D2 disconnecting device

The disconnecting device automatically separates the bottom terminal of the failed arrester from the earth.

The S3D2 provides a visual indication of the failure. It **gives the priority to continuity of service**. It is made of a resistor connected in parallel with an air spark gap associated with a cartridge

Operating Principle

The resistor is intended for conducting the leakage current of the surge arrester.

The disconnecter then behaves as a mere resistor under normal conditions, with an ohmic value far lower than the impedance of the surge arrester at low currents.

The air gap sparks over once the voltage at the resistor terminals exceeds a given value, i.e. once the current flowing through the arrester becomes significant : this occurs either in case of transient wave (high-frequency current impulse) or in case of failure (power frequency fault current). Thanks to an appropriate design of the gap electrodes, the device behaves as follows :

➤ Under transient waves, the arc is swept away from the cartridge by electromagnetic phenomena : the disconnecter remains shorted till the system voltage returns to a normal value and then resets

➤ Under fault currents, the power arc directly hits the cartridge and causes it to blow up due to both thermal and electrical stresses generated : the overpressure leads the disconnecter body to break, thus separating the earth connection from the surge arrester

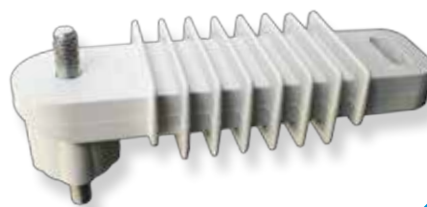

Continuity
of
supply

IF individual fault indicator

Whenever the operator requests continuity of protection, a failed surge arrester has to remain connected to the network in order to maintain protection.

The IF option includes a fault indicator module. In case of stress exceeding the energy absorption capability of the surge arrester, the short circuit current causes a red flag to appear. Any failed surge arrester can then be easily detected on site

Continuity
of
protection



MDC-3 discharge counter

The discharge counter with an ammeter records the number of impulses applied to the surge arrester. It indicates the total leakage current through the surge arrester. It is mainly used in conjunction with station surge arresters.

General : 0-100% ammeter scale calibrated for 1.5 mA at 50 %.

Performances:

- Lightning current impulse operating threshold :
100 A - 8/20
- Maximum permissible lightning current impulse :
110 kA - 4/10
- Maximum permissible long-duration current impulse :
800 A - 2000 μ s
- Residual voltage at 10 kA - 8/20 : < 4 kV peak
- Voltage drop under normal service conditions : < 10 V rms
- Protection degree : IP67



Operation



IDPF common fault indicator

This fault indicator permits the signaling of any current fault due to the failure of a surge arrester or any other equipment connected to the earth cable on which it is installed.

The IDPF is a fully autonomous device powered by the fault current. In the event of a failure of the monitored equipment, the electromagnetic indicator rotates to display its reflective orange face marked "DEFAUT". Its sensitivity is 15 A / 0.1 s.

It is mainly intended for sets of Distribution surge arresters.

The device complies with EDF HM-23/98/011/B specifications.





ENSTO

Ensto Novexia SAS
210, rue Léon Jouhaux - BP 10446
FR - 69656 Villefranche-sur-Saône cedex
Tel.: +33 (0)4 74 65 61 61
Fax: +33 (0)4 74 62 96 57
Email: infos.novexia@ensto.com

ensto.com

