









SJK4X95C

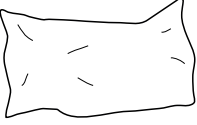
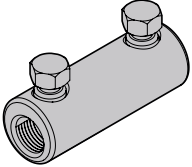

$U_o/U (U_m)$ kV	 mm ²	 mm ²
0,6/1 (1,2) kV	35-95	35-95

	CPEEPL68-19	675 mm	1		PEE64/150	1
	CPEEPL33-8	130 mm	4		PA23	1
	SLJ2.27		4		PEM-SJK4X95C PEM2034	1 1

1

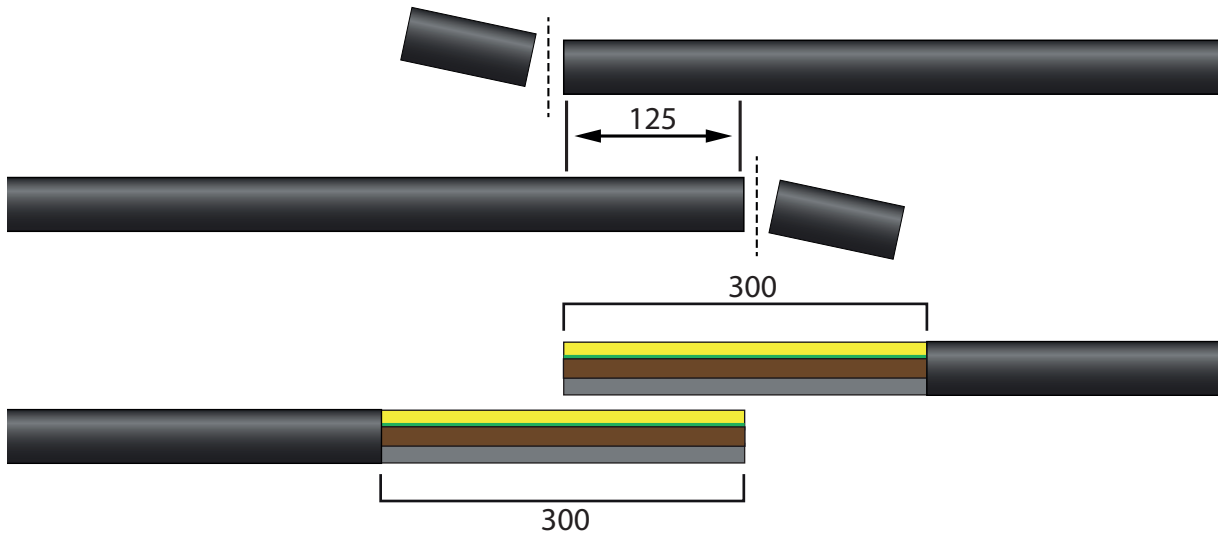

2

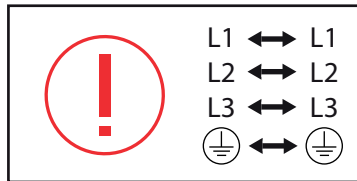
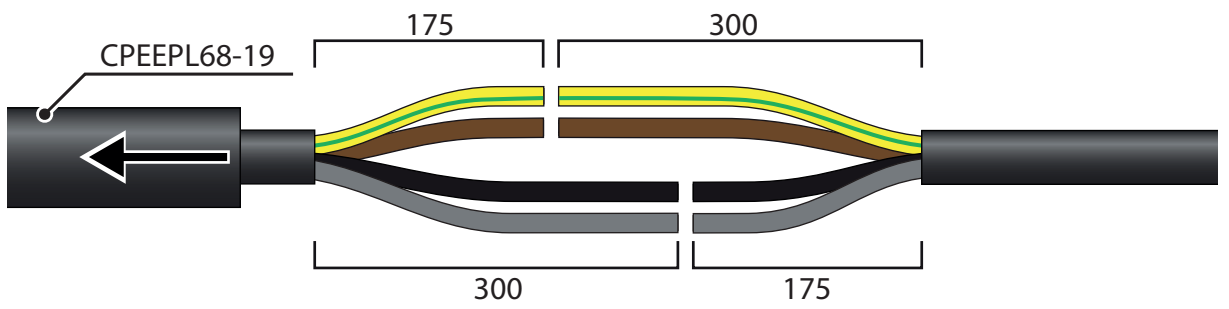

3

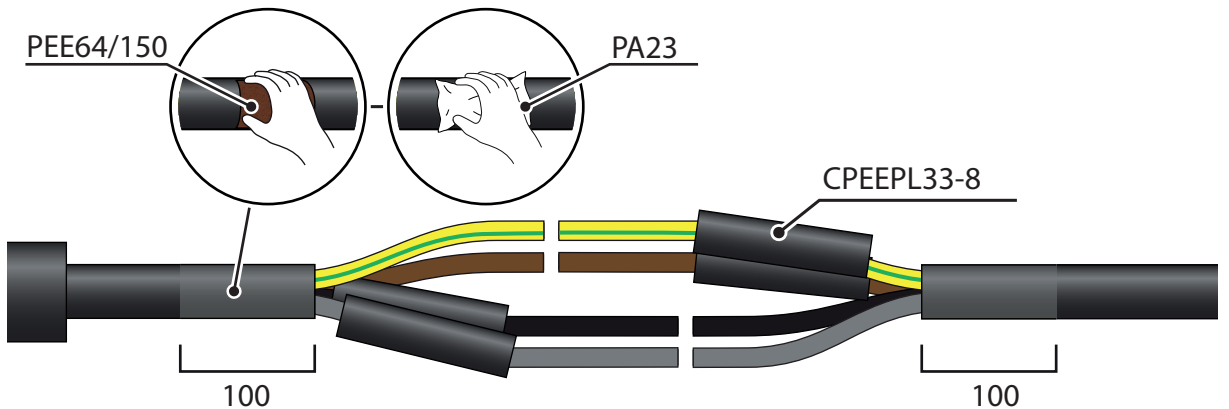

4

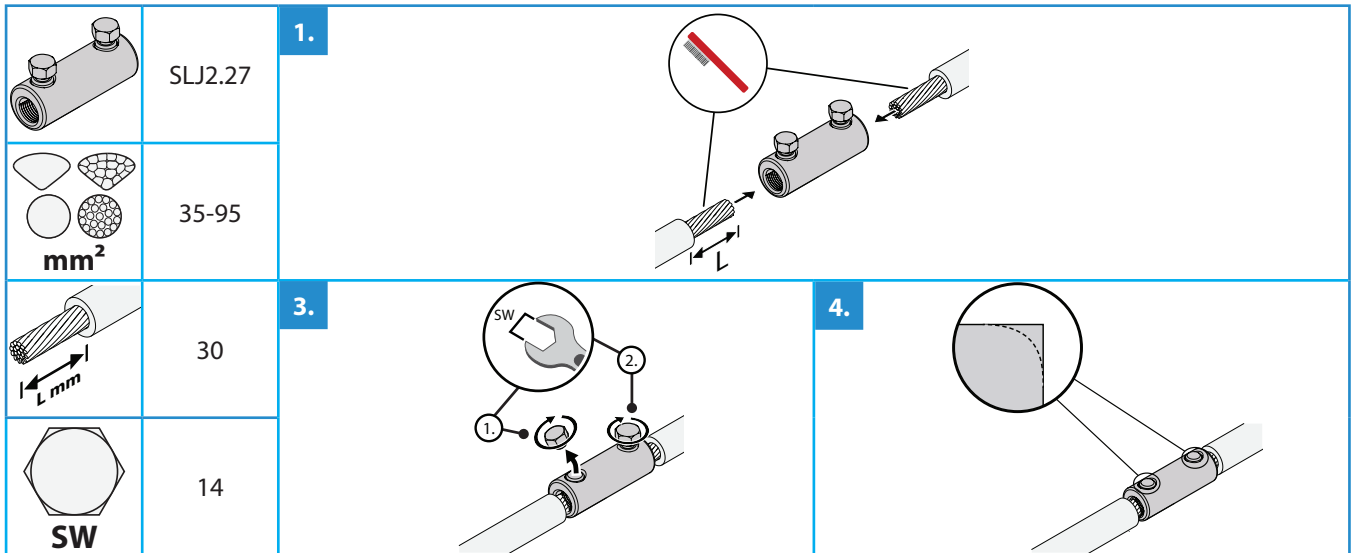

5

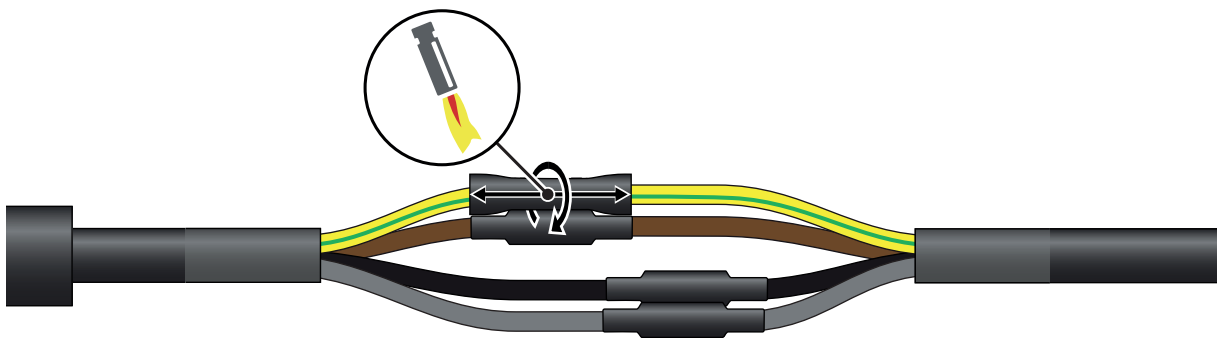

6

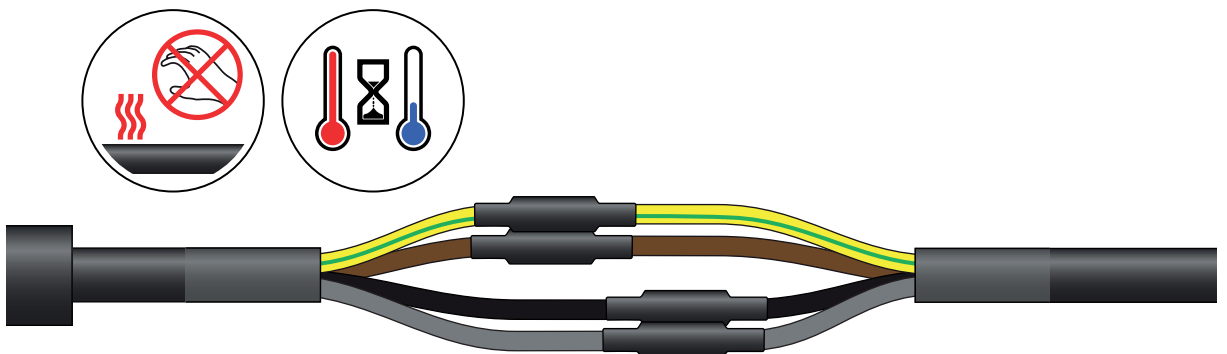

7

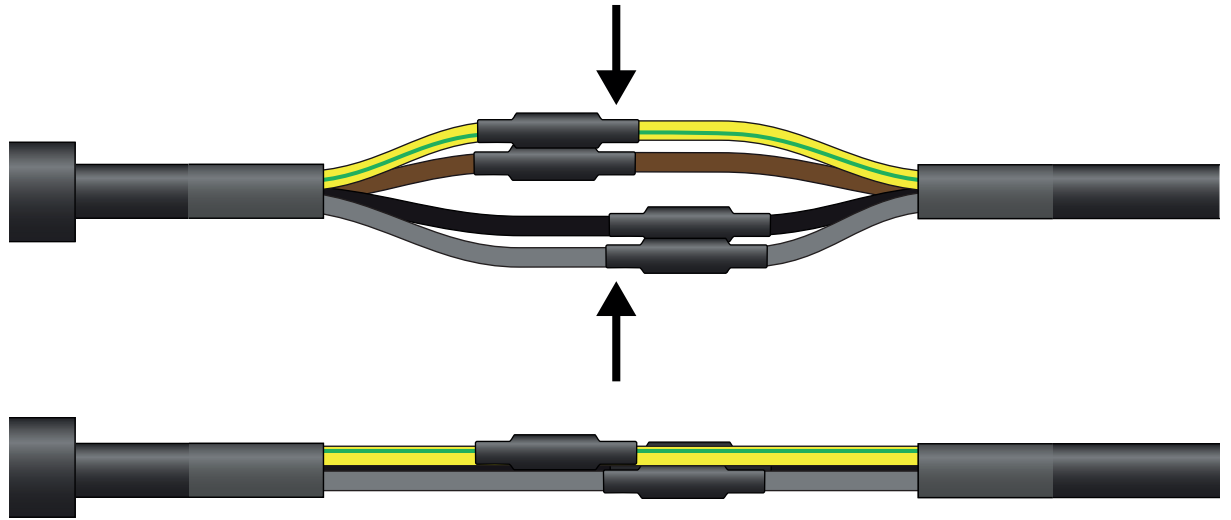

8

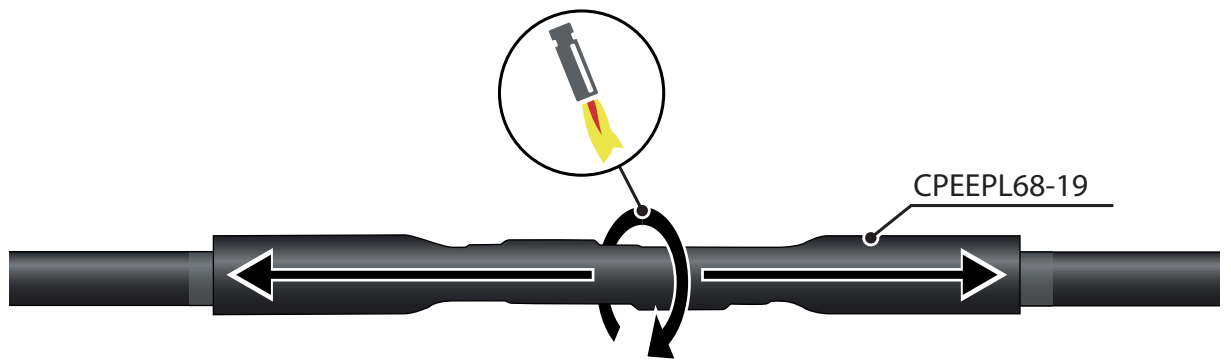

9

