

Ensto One Home

EVH161-HC000

EVH321-HC000

EVH161-HCR00

EVH321-HCR00



Quick Guide



Pikaopas



Snabbguide



Hurtigguide



Guida rapida

CE



User Guide

Safety Instructions



WARNING

Danger of electric shock! Risk of fire!

- *People who are not able to operate according to the instructions must not use this charger.*
- *Do not use this charger, if the charger itself or the charging cable appears to be damaged.*
- *The installation must only be done by an electrically skilled person.*





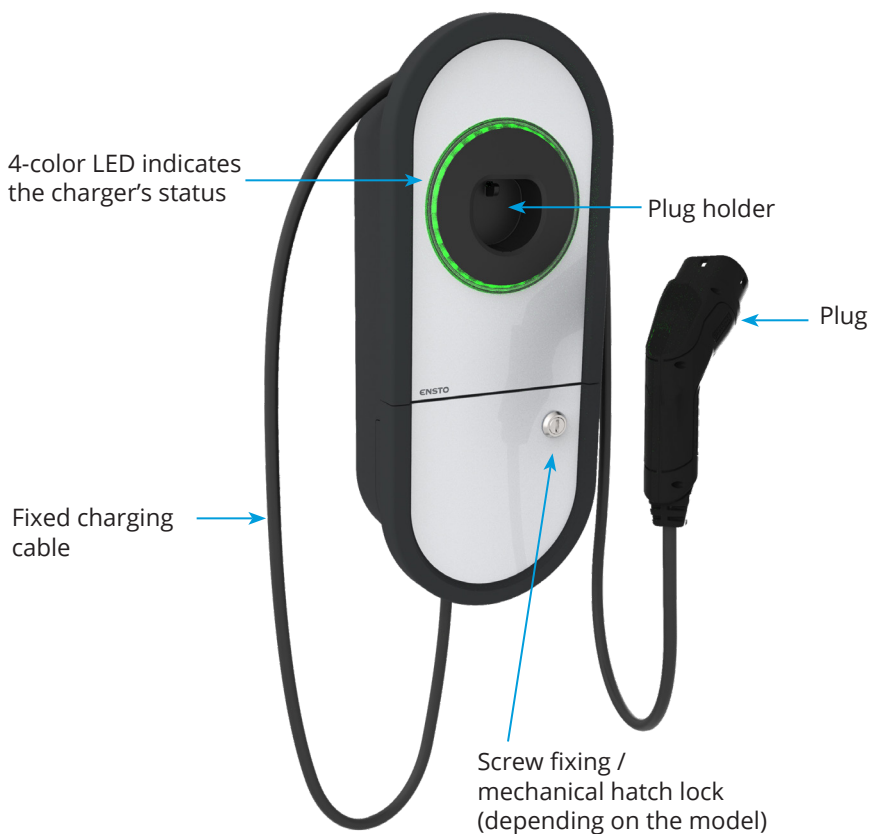

Ensto One Home Features

Available features depend on the charger model.





LED Indicator Lights

Charger status	LED
The charger is free and ready to use	
While you connect the charging cable	
Your vehicle is connected, charging has not started	
Your vehicle is connected, charging starts	
Charging is ongoing	
Error state	
Software update is ongoing. <i>Do not switch off the power or use the charger during the update.</i>	

Charging in "Free charging" mode

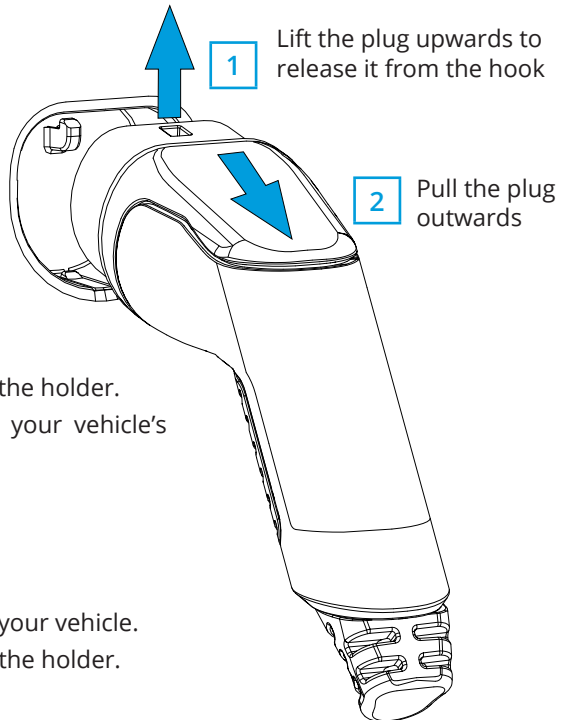

Start charging

- Remove the plug from the holder.
- Connect the plug into your vehicle's receptacle.

Stop charging

- Remove the plug from your vehicle.
- Put the plug back in to the holder.



Ensto Charger Control Application



Ensto Charger Control

Android version 5.0 and above
iOS version 8.0 and above

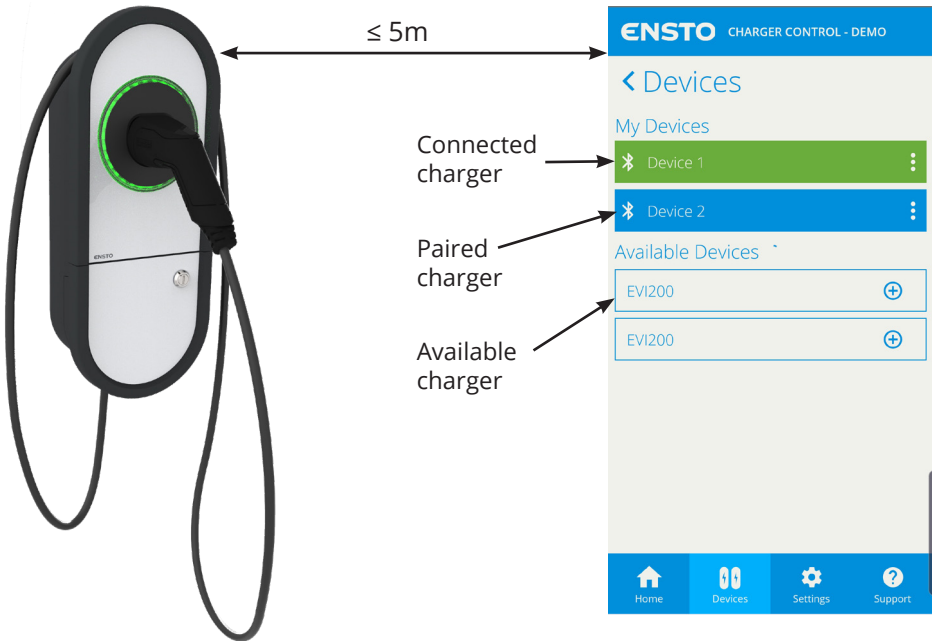

1. First switch off the charger from the main switch and then switch it on again.
2. Start the pairing procedure within 3 minutes.
3. Open the application.
4. Go to **"Devices"**.
5. Select from **"Available Devices"** the charger you want to pair with your mobile.
6. If the pairing fails the first time, try again starting from step 1.
7. When the pairing is completed, you can find your charger in **"Devices"**.

For more detailed instructions please see in the delivery included Installation and User Guide.



Instructions for Installer

Safety Instructions



Electrically skilled person

- The installation must only be done by an electrician with the appropriate qualifications.
- Read in the delivery included Installation and User Guide carefully before you start the installation work.



WARNING

Danger of electric shock! Risk of fire!

- *Improper installation can cause personal injury and property damage.*
- *Do not switch on the power supply before the installation work is completed.*

Power Supply

EVH161-HC000 / EVH321-HC000

Install the following protective devices to the supply line:

RCD	type A 30mA
MCB	EVH161-HC000: max. 16A
	EVH132-HC000: max. 32A

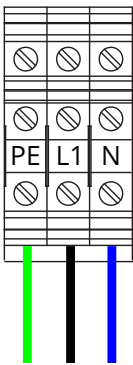

Supply
Cu 2.5 - 10 mm²

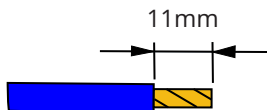

EVH161-HCR00 / EVH321-HCR00

Protective devices:
RCBO is integrated

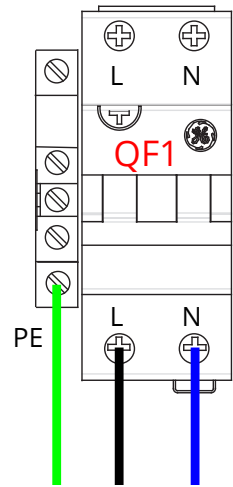

Supply
Cu 2.5 - 10 mm²



Käyttöohje

Turvallisuusohjeet



VAROITUS

Sähköiskun vaara! Palovaara!

- *Henkilöt, joilla ei ole riittävää osaamista toimia ohjeen mukaisesti, eivät saa käyttää tätä latauslaitetta.*
- *Älä käytä tätä latauslaitetta, jos latauslaite tai latauskaapeli vaikuttaa vaurioituneelta.*
- *Asennuksen saa suorittaa vain sähköalan ammattihenkilö.*

Ensto One Home ominaisuudet

Saatavilla olevat ominaisuudet riippuvat latauslaitteen mallista.





LED merkkivalot

Latauslaitteen tila	LED
Latauslaite on vapaa ja käyttövalmis	
Latauskaapelia kytkettäessä	
Ajoneuvo on kytketty, latausta ei ole aloitettu	
Ajoneuvo kytketty, lataustapahtuman aloitus	
Lataus on käynnissä	
Vikatilanne	
Ohjelmiston päivitys käynnissä. <i>Älä katkaise virtaa tai käytä latauslaitetta päivityksen aikana.</i>	

Lataus "Vapaa lataus" toimintamoodissa

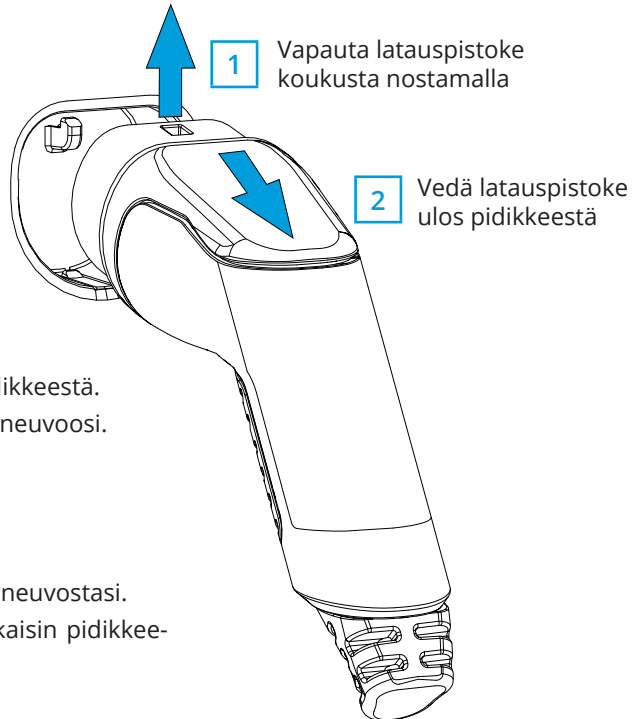

Aloita lataus

- Irrota latauspistoke pidikkeestä.
- Kytke latauspistoke ajoneuvoosi.

Lopeta lataus

- Irrota latauspistoke ajoneuvostasi.
- Aseta latauspistoke takaisin pidikkeeseen.



Ensto Charger Control sovellus



Ensto Charger Control

Android versio 5.0 ja uudempi
iOS versio 8.0 ja uudempi

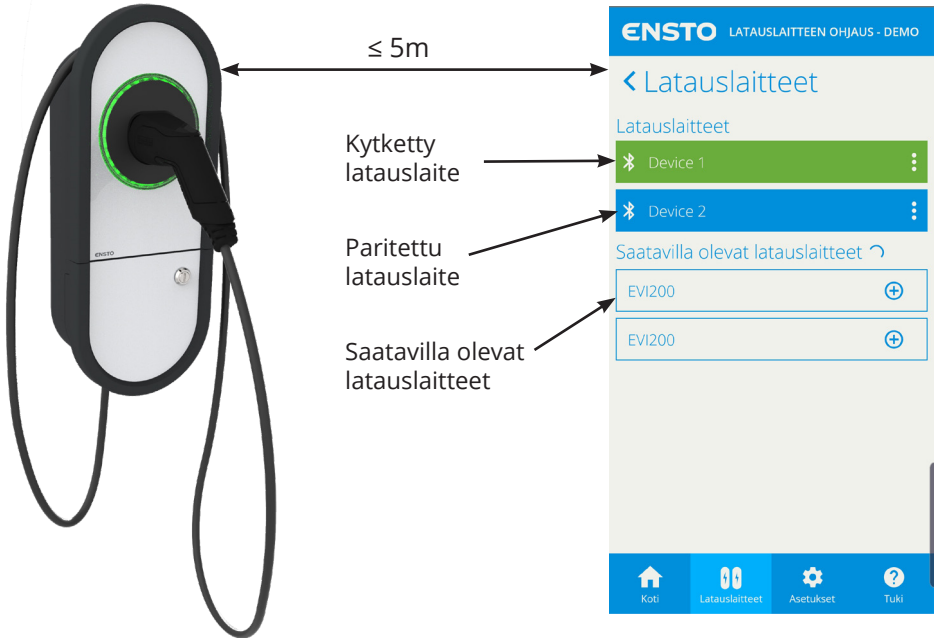

1. Katkaise ensin virta latauslaitteesta ja kytke sitten virta takaisin päälle.
2. Aloita paritus kolmen minuutin sisällä.
3. Avaa sovellus.
4. Mene valikkoon **"Latauslaitteet"**.
5. Valitse kohdasta **"Saatavilla olevat latauslaitteet"** latauslaite, jonka haluat parittaa mobiililaitteesi kanssa.
6. Jos paritus ei onnistu ensimmäisellä kerralla, aloita paritustapahtuma uudelleen alusta.
7. Kun paritus on valmis, löydät latauslaitteen valikosta **"Latauslaitteet"**.

Katso lisäohjeita pakkauksessa olevasta englanninkielisestä ohjeesta.
Voit myös ladata suomenkielisen asennus- ja käyttöohjeen www.ensto.com.



Ohjeita asentajalle

Turvallisuusohjeet



Sähköalan ammattihenkilö

- Asennuksen saa suorittaa vain sähköalan ammattihenkilö, jolla on siihen riittävä pätevyys.
- Lue pakkauksessa oleva englanninkielinen ohje huolellisesti ennen asennustyön aloittamista. Voit myös ladata suomenkielisen asennus- ja käyttöohjeen www.ensto.com.



VAROITUS

Sähköiskun vaara! Palovaara!

- *Virheellinen asennus voi aiheuttaa henkilö- ja omaisuusvahinkoja.*
- *Älä kytkä latauslaitetta verkkojännitteeseen ennen kuin asennustyö on valmis.*

Syöttöliitântä

EVH161-HC000 / EVH321-HC000

Asenna seuraavat suojalaitteet sähkökeskukseen:

RCD	tyyppi A 30mA
MCB	EVH161-HC000: maks. 16A
	EVH132-HC000: maks. 32A

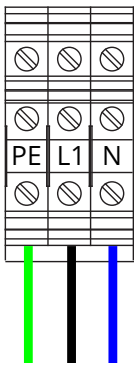

Syöttö
Cu 2.5 - 10 mm²

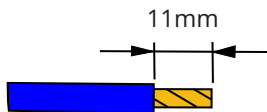

EVH161-HCR00 / EVH321-HCR00

Suojalaitteet:
RCBO on integroitu

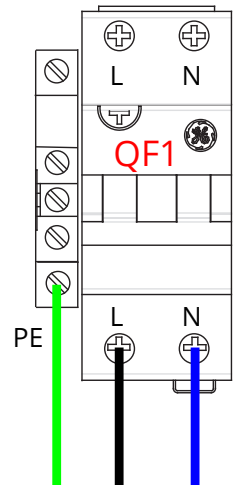

Syöttö
Cu 2.5 - 10 mm²



Bruksanvisning

Säkerhetsinstruktioner



VARNING

Fara för elektrisk stöt! Brandrisk!

- *Personer som inte har tillräcklig kunskap att följa givna anvisningar, får inte använda den här laddstationen.*
- *Använd inte den här laddstationen, om själva laddstationen eller laddkabeln verkar vara skadad.*
- *Endast en fackkunning person får installera laddstationen.*





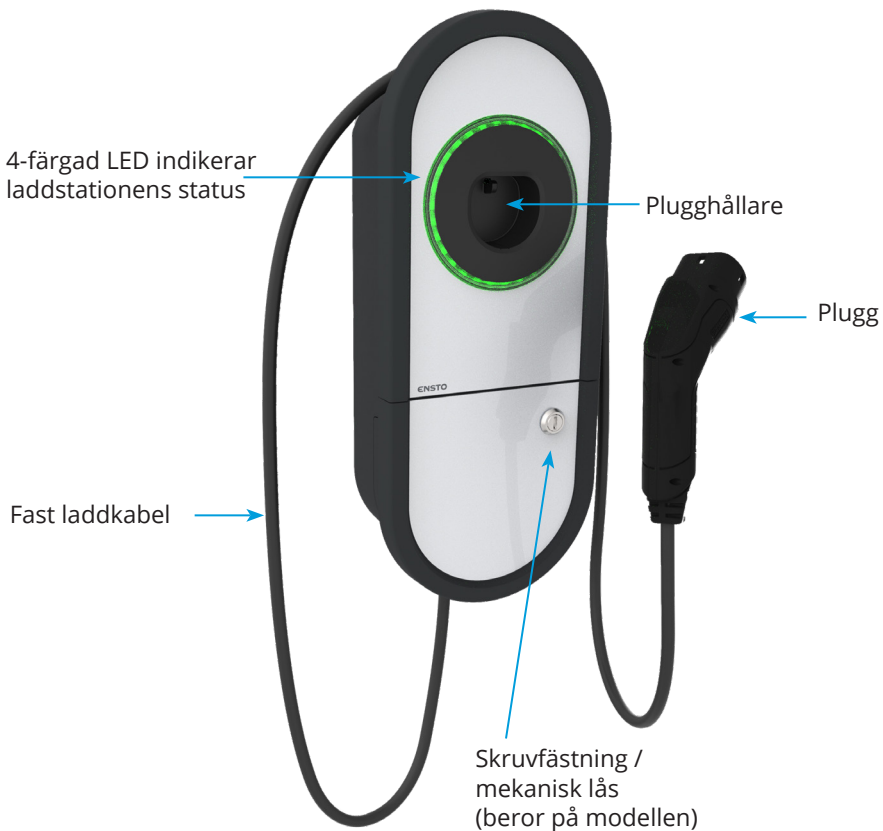

Ensto One Home egenskaper

Tillgängliga egenskaper beror på laddstationens modell.





LED indikator

Laddstationens status	LED
Laddstationen är ledig och kan användas	
Användaren ansluter laddkabeln till elfordon	
Elfordon är anslutet, laddning har inte startat	
Elfordon är anslutet, laddning startar	
Laddning pågår	
Feltillstånd	
Uppdatering av programvaran pågår. <i>Stäng inte av strömmen eller använd laddstationen under uppdatering.</i>	

Laddning i "Gratis laddning" läge

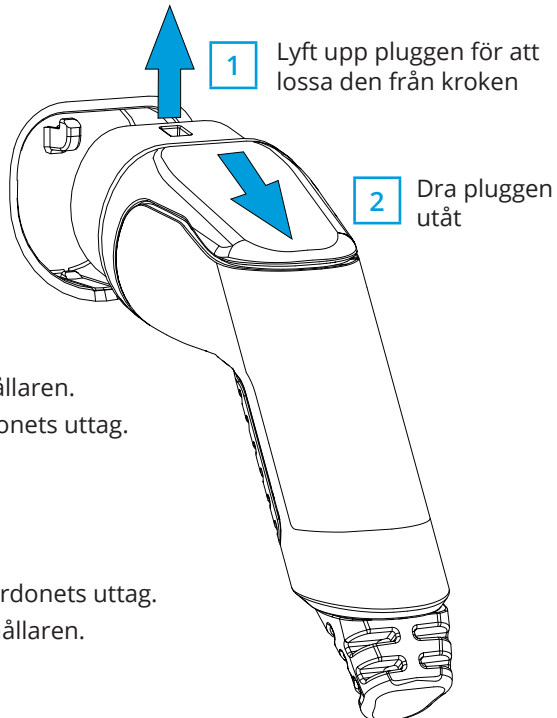

Starta laddning

- Ta bort pluggen från hållaren.
- Anslut pluggen till fordonets uttag.

Sluta laddning

- Ta bort pluggen från fordonets uttag.
- Sätt tillbaka pluggen i hållaren.



Ensto Charger Control Applikation



Ensto Charger Control

Android version 5.0 och nyare
iOS version 8.0 och nyare

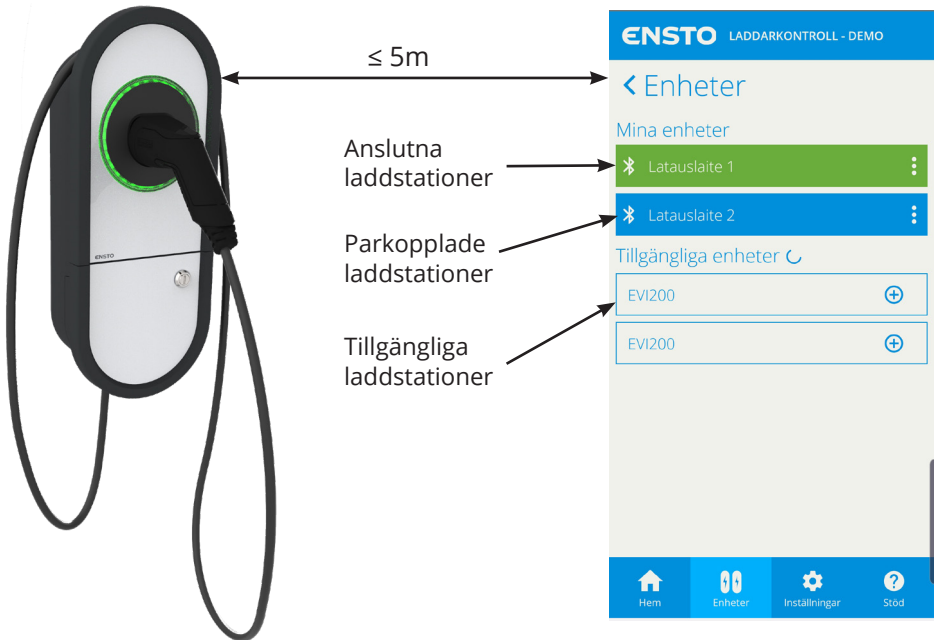

1. Stäng först av strömmen från laddstationen och slå sedan på den igen.
2. Starta parkoppling inom 3 minuter.
3. Öppna applikationen.
4. Gå till **"Enheter"**.
5. Välj från **"Tillgängliga enheter"** den laddstation som du vill parkoppla med din mobil.
6. Om parkoppling misslyckas första gången, försök igen från början.
7. När parkoppling är klar hittar du din laddstation i **"Enheter"**.

För mera detaljerade instruktioner se den medföljande engelska guiden. Du kan också ladda ner den svenska installations- och bruksanvisningen på www.ensto.com



Anvisningar för Installatör

Säkerhetsinstruktioner



Fackkunnig person

- Endast en fackkunnig person får installera laddstationen.
- Läs den medföljande engelska guiden noga innan du börjar installationsarbetet. Du kan också ladda ner den svenska installations- och bruksanvisningen på www.ensto.com



VARNING

Fara för elektrisk stöt! Brandrisk!

- *Felaktig installation kan leda till personskada eller materiella skador.*
- *Slå inte på strömförsörjning innan installationen är klar.*

Nätanslutning

EVH161-HC000 / EVH321-HC000

Installera följande skyddsanordningar i elcentralen:

RCD	typ A 30mA
MCB	EVH161-HC000: max. 16A
	EVH132-HC000: max. 32A

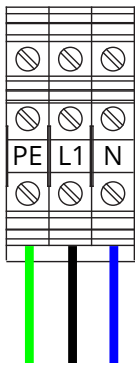

Matarkabel
Cu 2.5 - 10 mm²

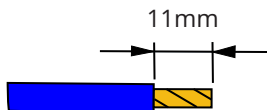

EVH161-HCR00 / EVH321-HCR00

Skyddsanordningar:
RCBO är integrerad

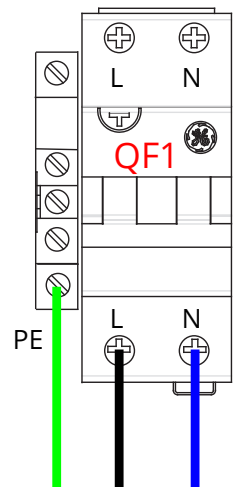

Matarkabel
Cu 2.5 - 10 mm²



Bruksanvisning

Sikkerhetsinstruksjoner



ADVARSEL

Risiko for elektrisk sjokk! Brannfare!

- *Personer som ikke har tilstrekkelig kunnskap til å følge gitte instruksjoner, skal ikke bruke denne laderen.*
- *Hvis skader på lader eller ladekabel, skal ikke laderen benyttes.*
- *Ensto One Home lader skal kun installeres av kvalifisert elektriker eller installatør.*







Ensto One Home egenskaper

Tilgjengelige egenskaper er avhengig av ladermodell.





Status LED lys mønster

Lader status	LED
Laderen er ledig og klar for bruk	
Tilkobling av ladekabel	
Bil tilkoblet, lading ikke startet	
Bil tilkoblet, lading startet	
Lading pågår	
Feil på lader	
Software oppgradering pågår. <i>Slå ikke av strømmen til laderen mens oppdatering pågår.</i>	

Lading i "Gratis lading" modus

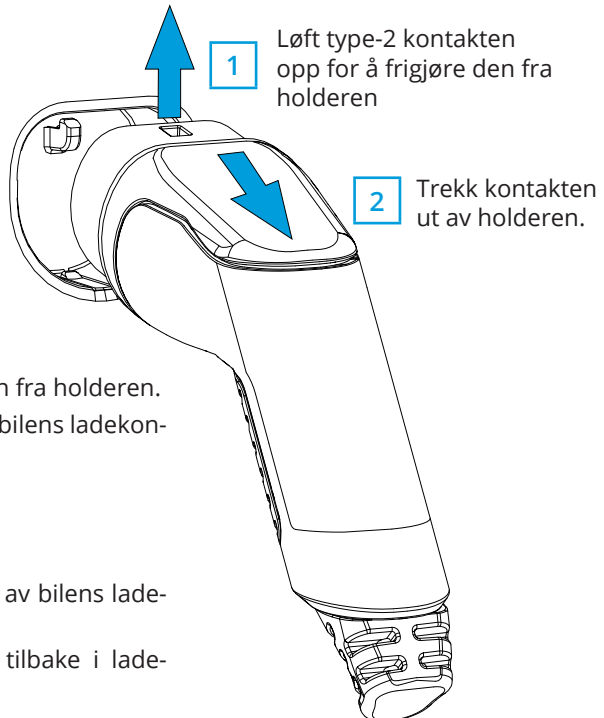

Starte lading

- Frigjør type-2 kontakten fra holderen.
- Sett type-2 kontakten i bilens ladekontakt.

Stopp lading

- Ta type-2 kontakten ut av bilens ladekontakt.
- Sett type-2 kontakten tilbake i laderens holder.



Ensto Charger Control applikasjon



Ensto Charger Control

Android versjon 5.0 og nyere
iOS versjon 8.0 og nyere



≤ 5m

Tilkoblet lader

Kjente ladere

Tilgjengelige ladere

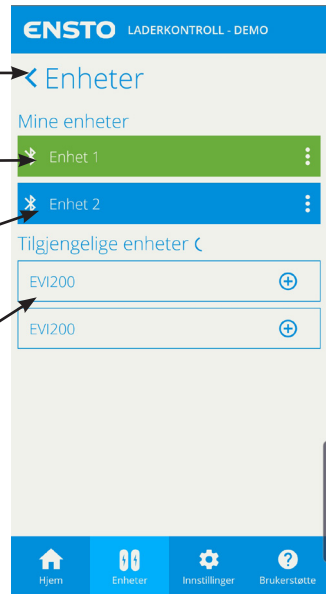

1. Kutt tilførselen til laderen ved å slå av og på sikring til laderen.
2. Start tilkoblings prosedyren innen 3 minutter.
3. Åpne applikasjonenn.
4. Gå til **"Enheter"**.
5. Velg laderen fra listen under **"Tilgjengelige enheter"** som du vil knytte applikasjonen til.
6. Hvis tilknytningen ikke lyktes, prøv igjen fra steg 1.
7. Når tilknytningen er komplett, kan du hente opp din lader fra **"Enheter"**.

For mer detaljerte instruksjoner, vennligst se den vedlagte engelske guiden. Du kan også laste ned den norske installasjons- og bruksveiledningen på www.ensto.com



Instruksjoner for installatør

Sikkerhetsinstruksjoner



Kvalifisert elektriker eller installatør

- Ensto One Home lader skal kun installeres av kvalifisert elektriker eller installatør.
- Les den vedlagte engelske guiden nøye før du begynner installasjonsarbeidet. Du kan også laste ned den norske installasjons- og bruksveiledningen på www.ensto.com.



Advarsel

Risiko for elektrisk sjokk! Brannrisiko!

- Ikke forskriftsmessig installasjon kan medføre personskade og materielle skader.
- Slå ikke på strøm tilførsel før installasjons arbeide er ferdigstilt.

Strømtilførsel

EVH161-HC000 / EVH321-HC000

Strømtilførsel må installeres med følgende vern:

RCD	type A 30mA
MCB	EVH161-HC000: max. 16A
	EVH132-HC000: max. 32A

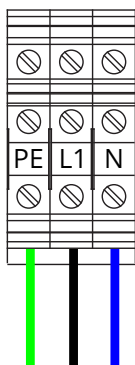

Strømtilførsel
Cu 2.5 - 10 mm²

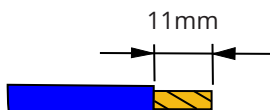

EVH161-HCR00 / EVH321-HCR00

Strøm og jordfeils vern er inkludert i laderen.

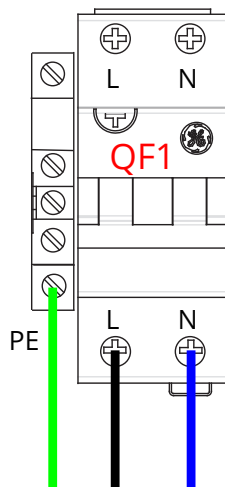

Strømtilførsel
Cu 2.5 - 10 mm²



Guida utente

Indicazioni per la sicurezza



AVVERTENZE

Rischio di scossa elettrica o incendio!

- *Persone che non possono operare in accordo con il presente manuale non devono usare la stazione di ricarica.*
- *Non usare la stazione di ricarica se i cavi di ricarica o la stazione stessa risultano essere danneggiati.*
- *L'installazione deve essere eseguita solo da personale qualificato.*







Caratteristiche principali di Ensto One Home

Le funzionalità disponibili dipendono dal modello della stazione di ricarica.





Indicatori LED

Stato della stazione di ricarica	LED
La stazione di ricarica è libera e pronta all'uso	
Durante il collegamento del cavo di ricarica	
Veicolo connesso ma non in carica	
Veicolo connesso, inizio carica	
Ricarica in corso	
Errore	
Aggiornamento del software in corso. <i>Non scollegare o usare la stazione di ricarica durante l'aggiornamento.</i>	

Ricarica in modalità "Ricarica libera"

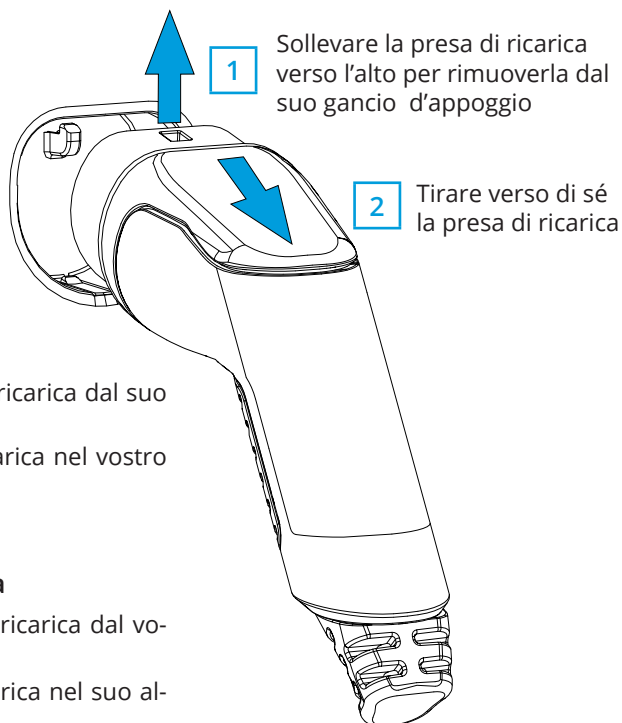

Per iniziare la ricarica

- Rimuovere la presa di ricarica dal suo alloggiamento.
- Inserire la presa di ricarica nel vostro veicolo.

Per terminare la ricarica

- Rimuovere la presa di ricarica dal vostro veicolo.
- Riporre la presa di ricarica nel suo alloggiamento.



Applicazione Ensto Charger Control



Ensto Charger Control

Versione Android 5.0 e superiori

Versione iOS 8.0 e superiori



1. Spegner la stazione di ricarica tramite l'interruttore principale ed accenderla nuovamente.
2. Avviare la procedura per associare il dispositivo cellulare entro 3 minuti dall'accensione.
3. Aprire l'applicazione.
4. Andare in "**Devices**".
5. Selezionare da "**Dispositivi disponibili**" la stazione di ricarica da associare al dispositivo cellulare.
6. Se il collegamento non va a buon fine, riprovare iniziando dal punto 1.
7. A connessione completata, potrai trovare la stazione di ricarica collegata in "**I miei dispositivi**".

Per istruzioni più dettagliate, consultare il Manuale di installazione e d'uso incluso nella confezione. È possibile scaricare il manuale di installazione e d'uso in italiano dal sito www.ensto.com.



Indicazioni per l'installatore

Indicazioni per la sicurezza



Personale qualificato

- L'installazione deve essere eseguita solo da un elettricista qualificato.
- Leggere attentamente il Manuale di installazione e d'uso incluso nella confezione prima di procedere con l'installazione. È possibile scaricare il manuale di installazione e d'uso in italiano dal sito www.ensto.com.



AVVERTENZE

Rischio di scossa elettrica o incendio!

- *Un'installazione errata può causare gravi lesioni a persone e danni alle cose.*
- *Non attivare l'alimentazione elettrica prima che l'installazione sia completata.*

Alimentazione elettrica

EVH161-HC000 / EVH321-HC000

Installare i seguenti dispositivi di protezione sulla linea di alimentazione:

RCD	tipo A 30mA
MCB	EVH161-HC000: max. 16A
	EVH132-HC000: max. 32A

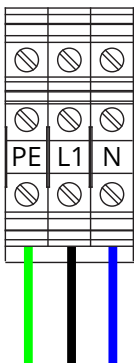

Alimentazione
Cu 2.5 - 10 mm²

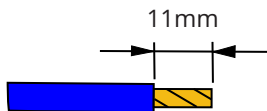

EVH161-HCR00 / EVH321-HCR00

Dispositivi di protezione:
RCBO è integrato

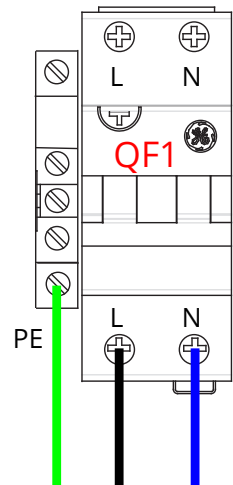

Alimentazione
Cu 2.5 - 10 mm²

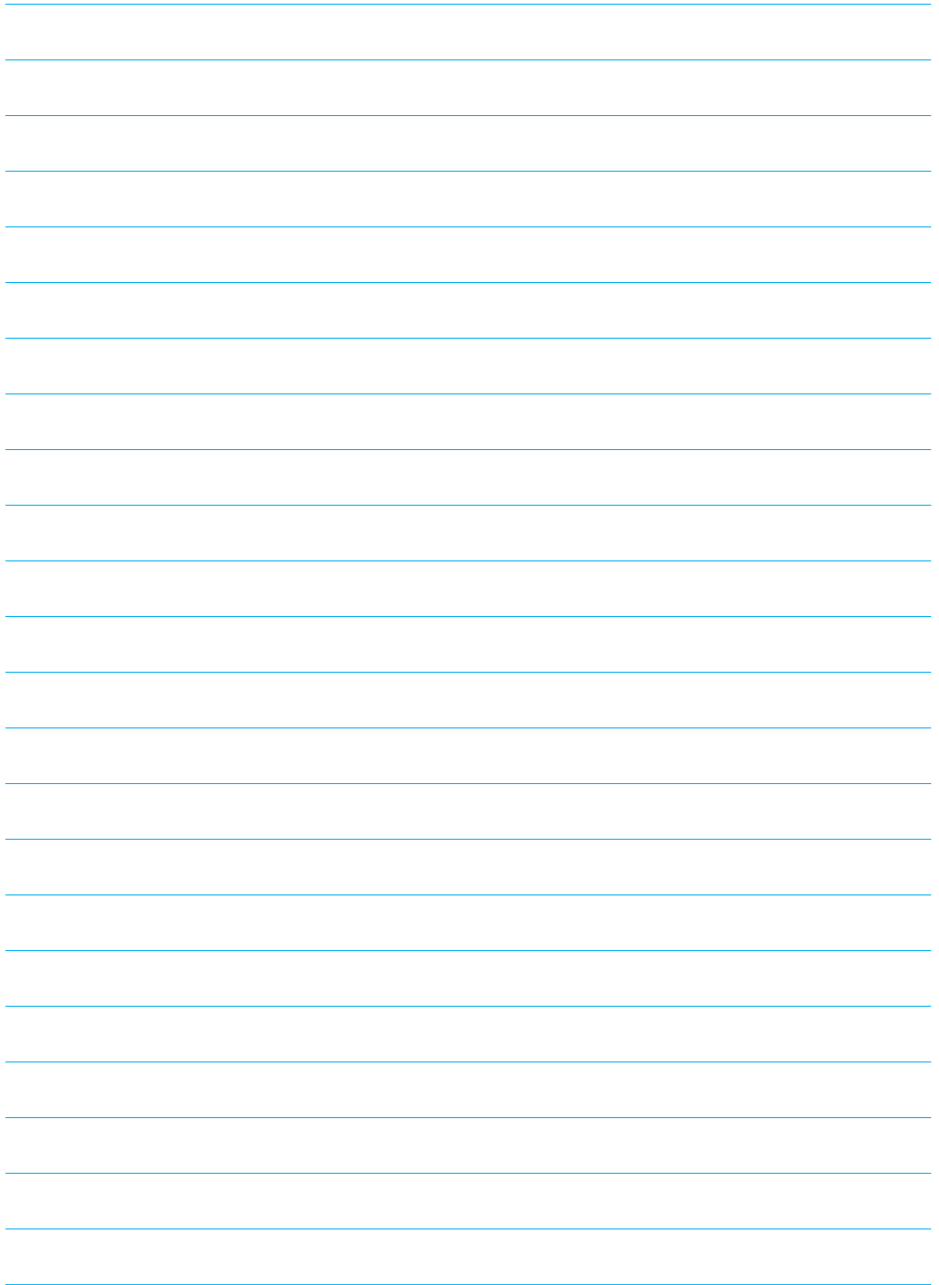

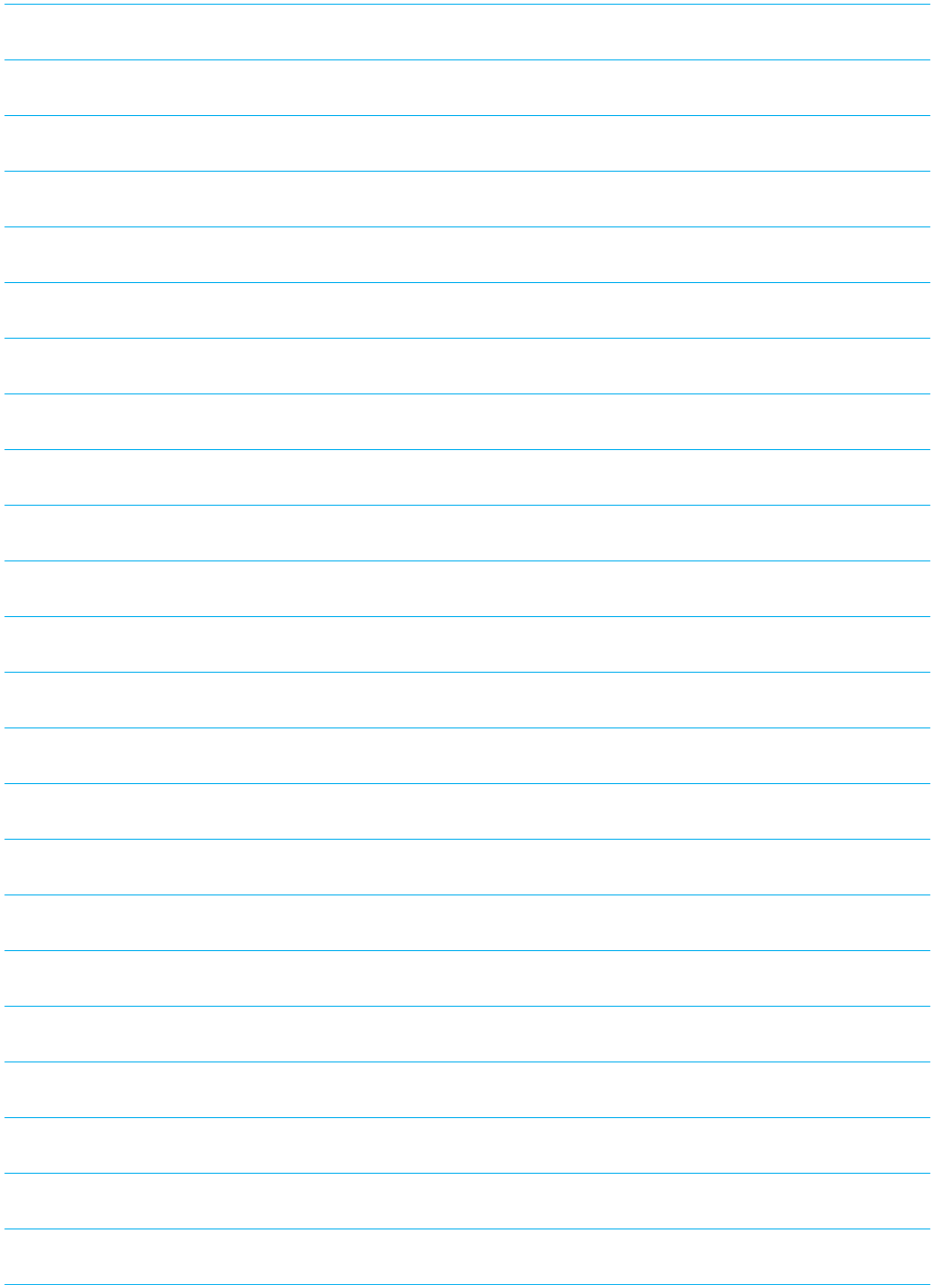

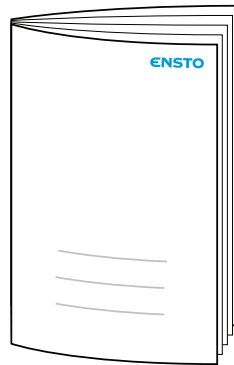

ENSTO

Ensto Chago Oy
Ensio Miettisen katu 2, P.O. Box 77
FIN-06101 Porvoo, Finland
Tel. +358 20 47 621
Customer service +358 200 29 007
ensto@ensto.com

