









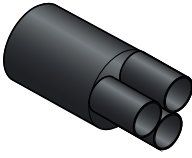
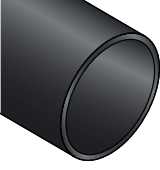
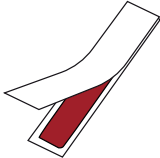

SJE42

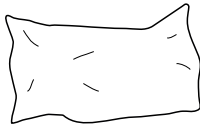
U_o/U_m (kV)	  mm ²
6/10 (12) kV	25-95
12/20 (24) kV	25-95

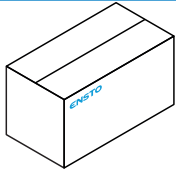
	SBO3.4		1				
	CPEEPL45-12/250		3				
	SSM83.3		2				
	PEE64/150	150 mm	1				
	PA23		1				
	PEM-SJE42		1				

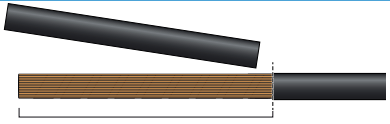
		12 kV mm2	24 kV mm2	 A mm
HJ11.1202C	PEM-HJ11_1202C	35-95		210
HJ11.2402C	PEM-HJ11_2402C		25-95	230
CJH11.2402C	PEM-CJH11_2402C	35-95	25-95	190
CJ11.2402C	PEM-CJ11_2402C	35-95	25-95	190

1



PA23

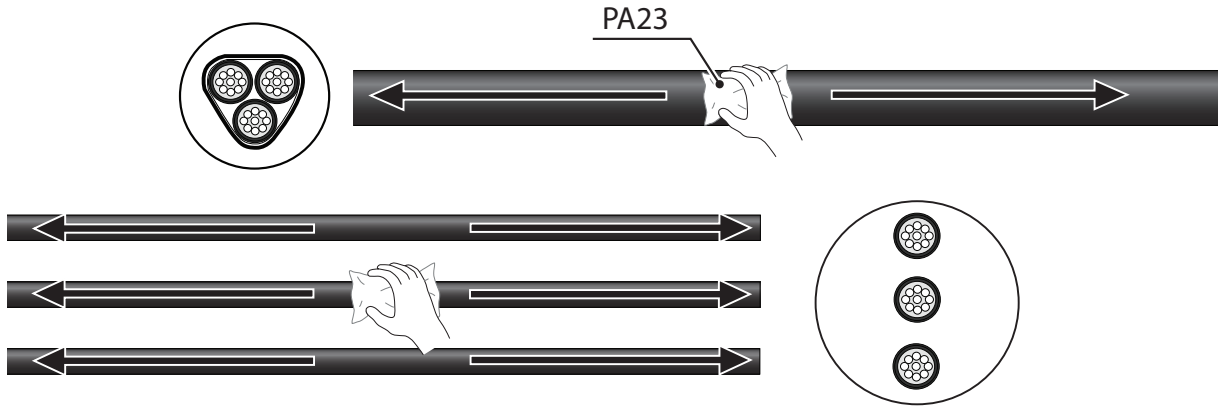

2

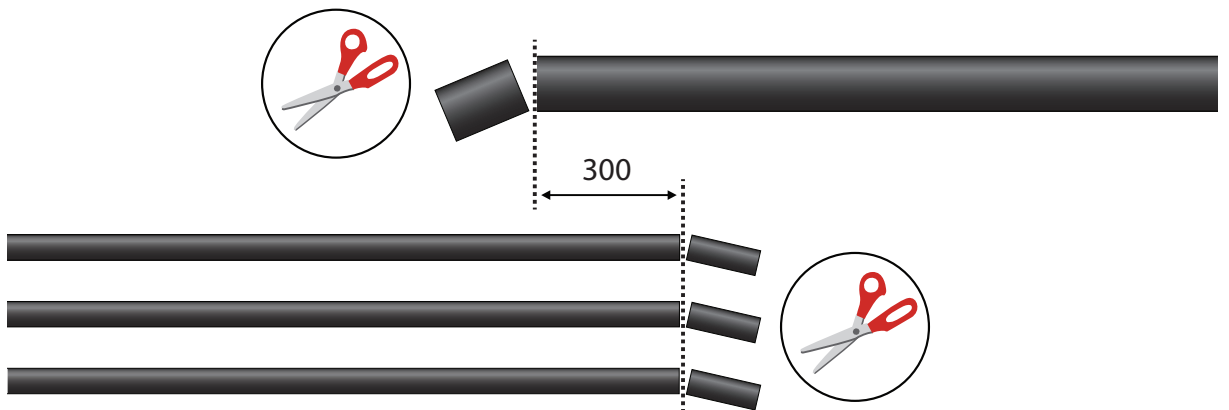

3

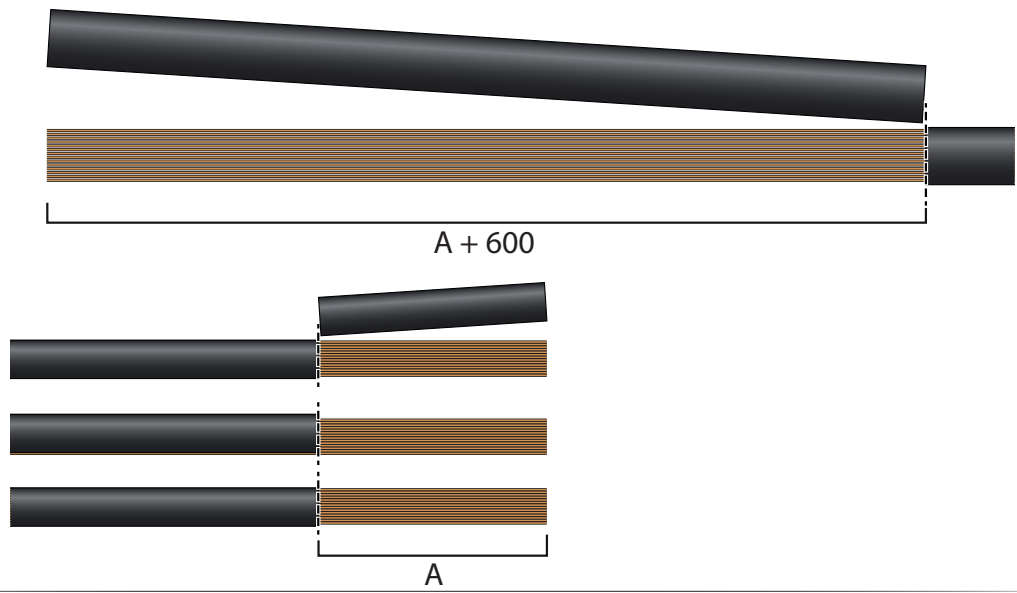

4

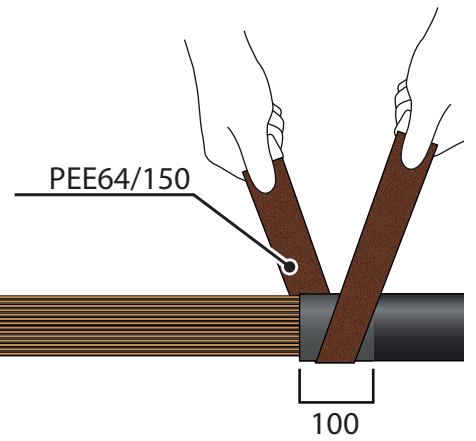
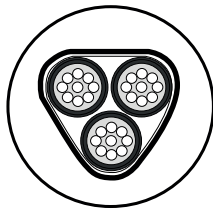

5

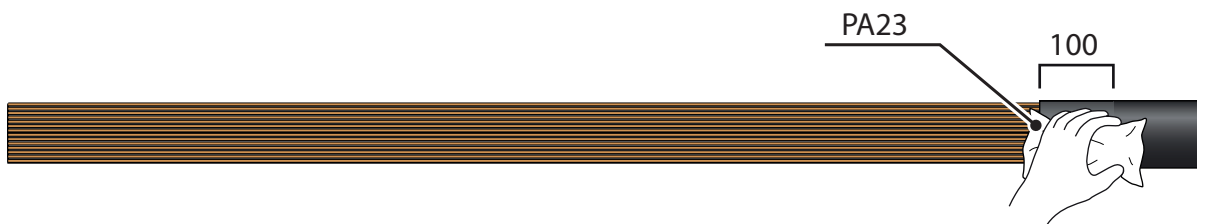

6

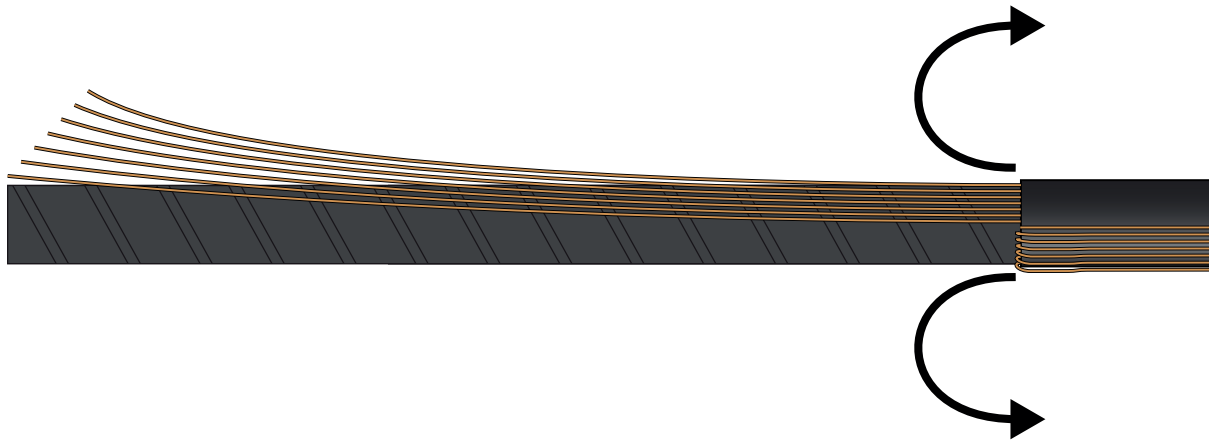

7

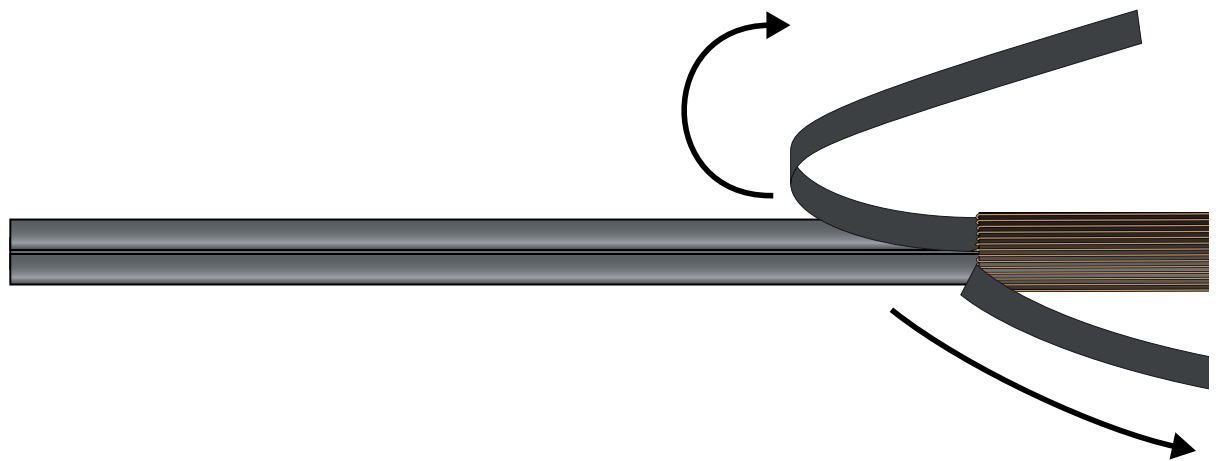

8

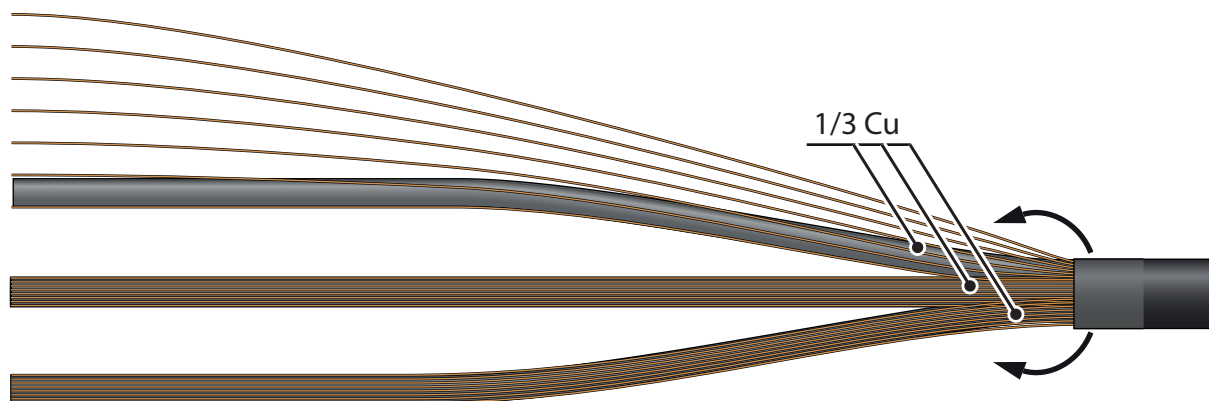

9

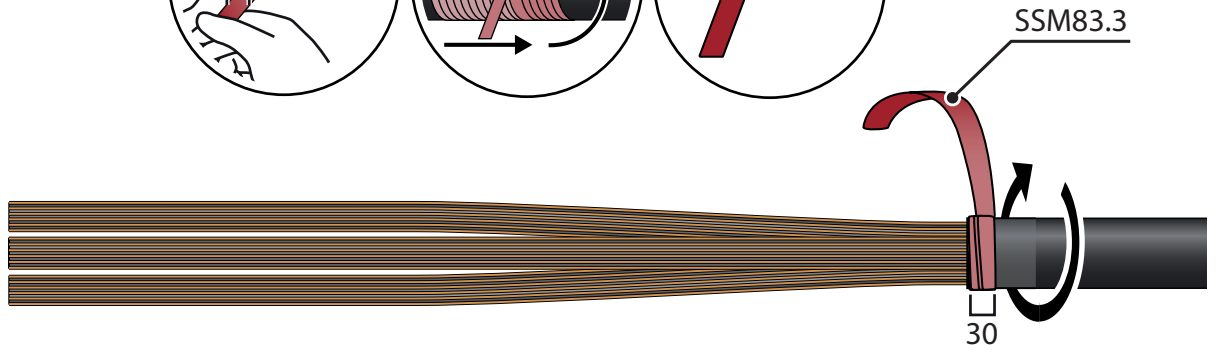
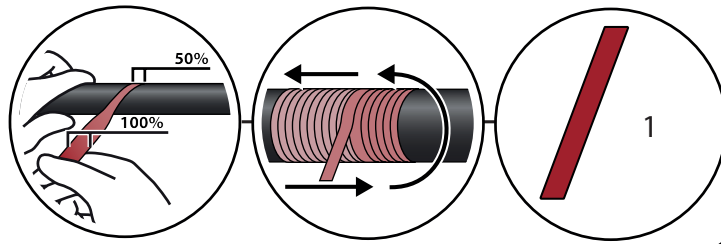

10

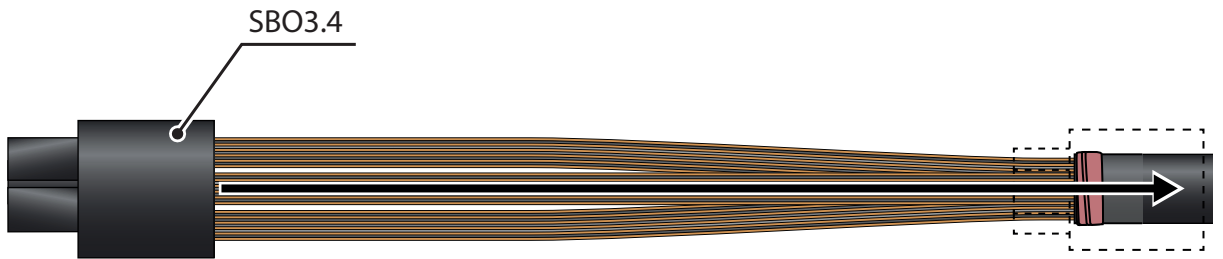

11

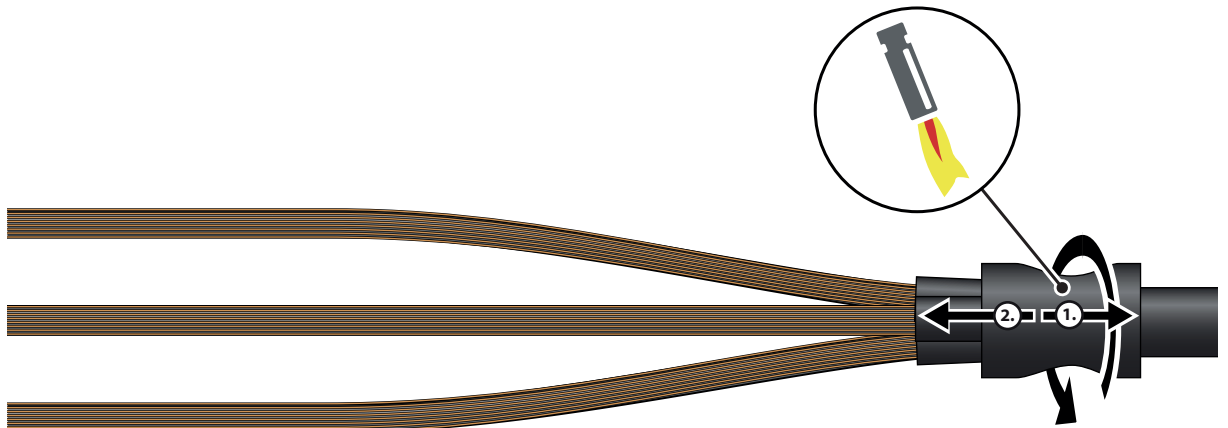

12

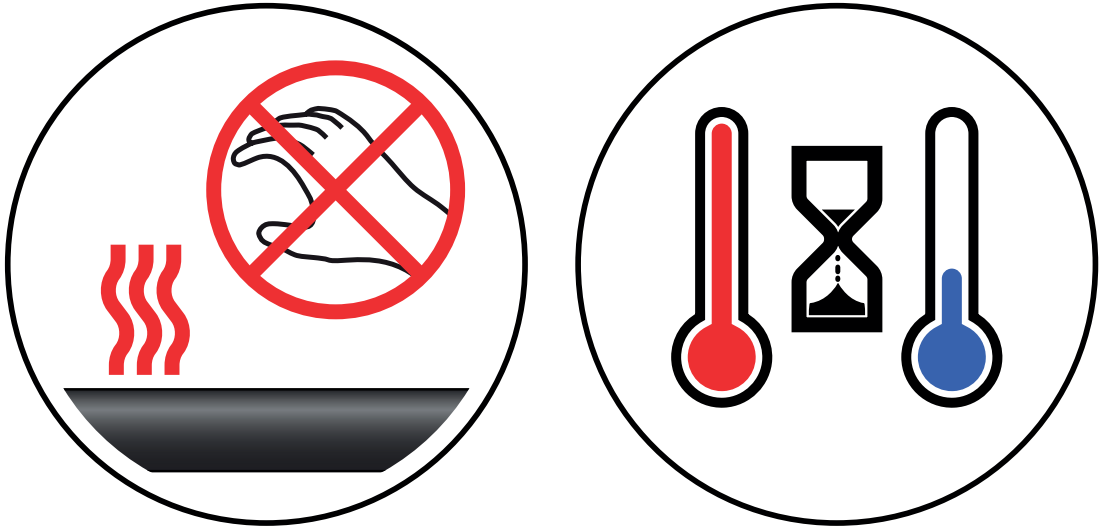

13

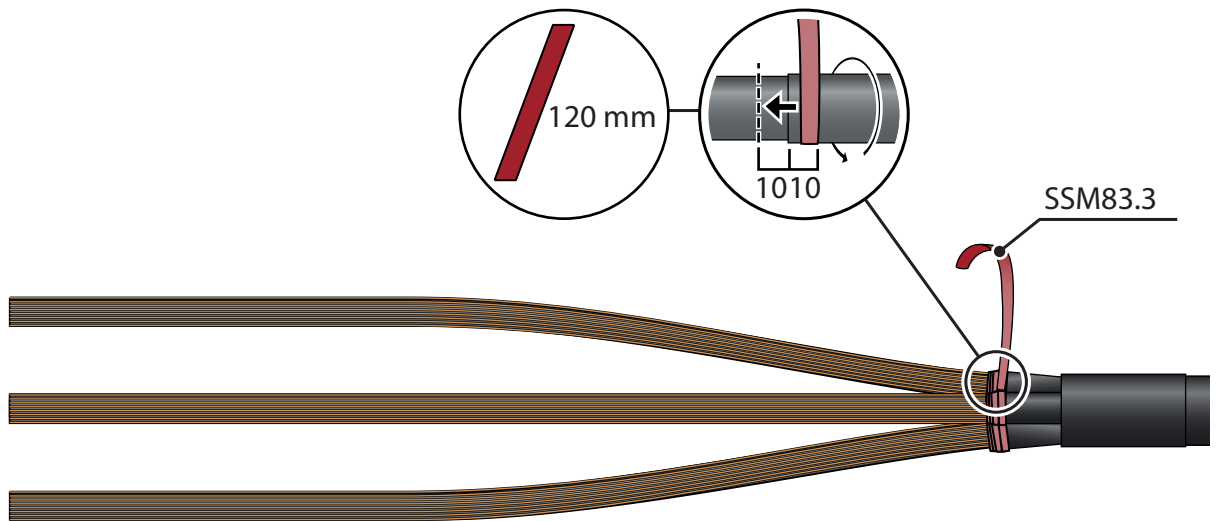

14

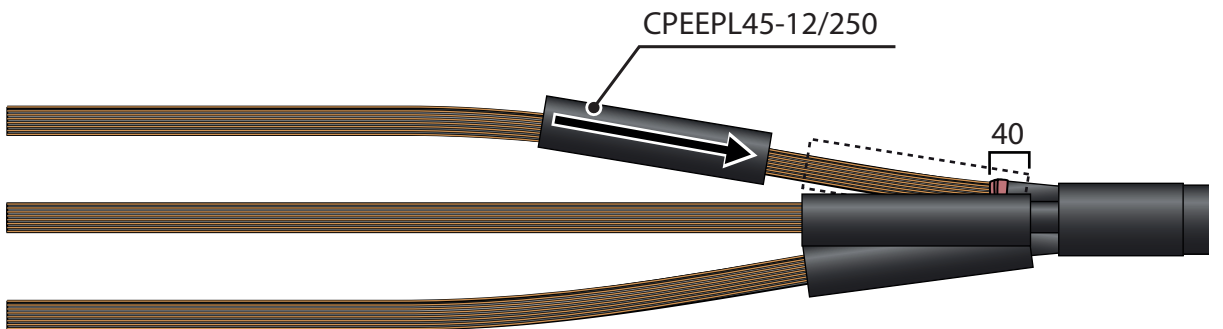

15

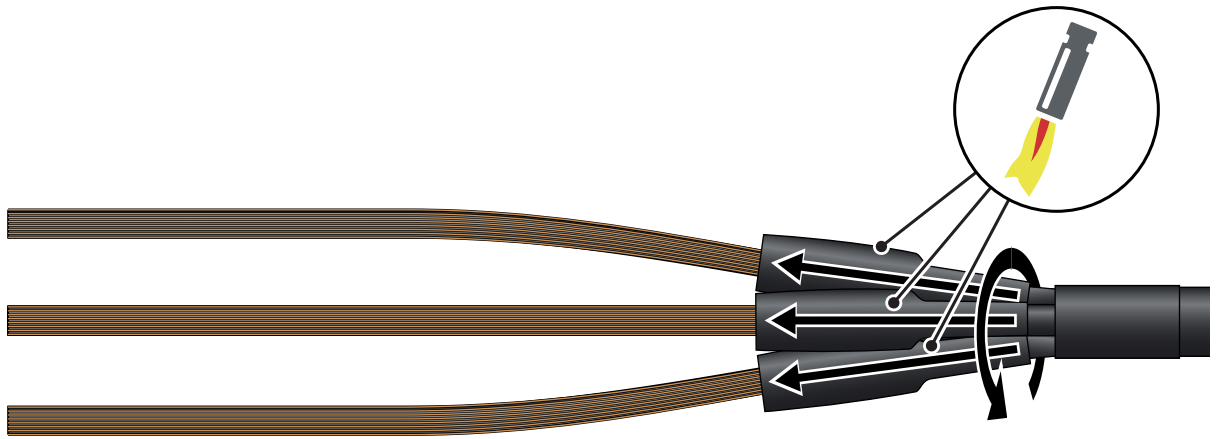

16

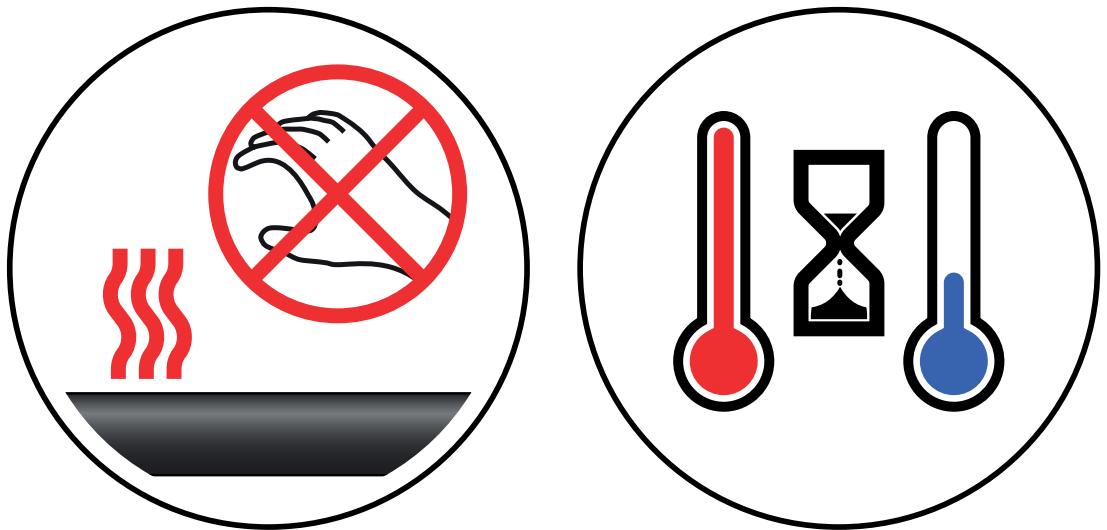

17

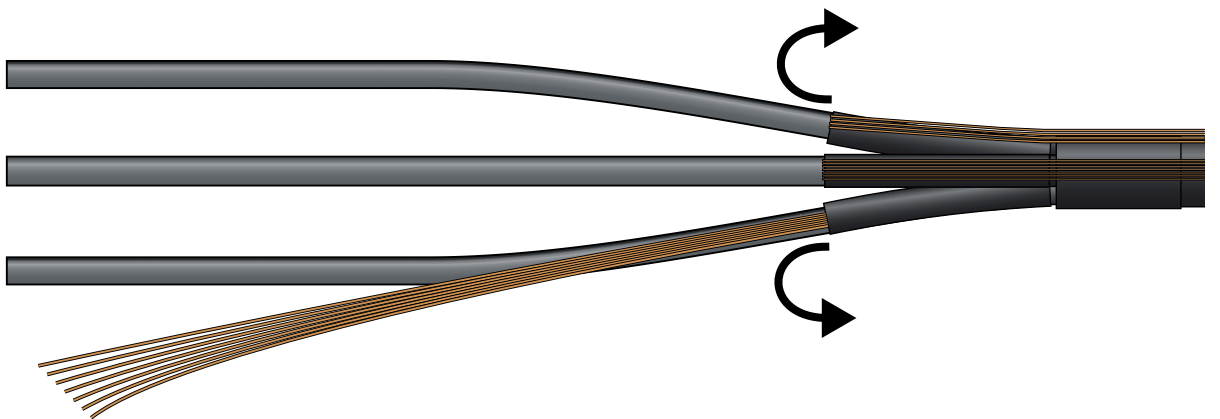

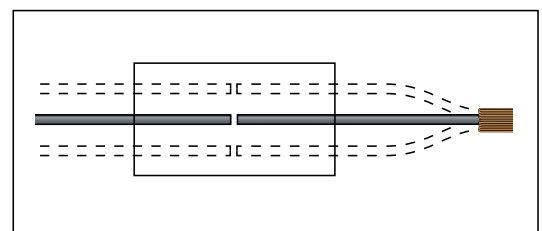
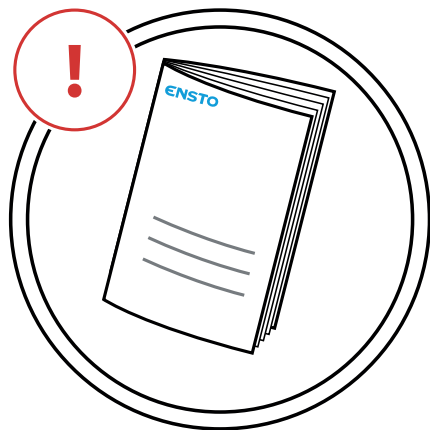
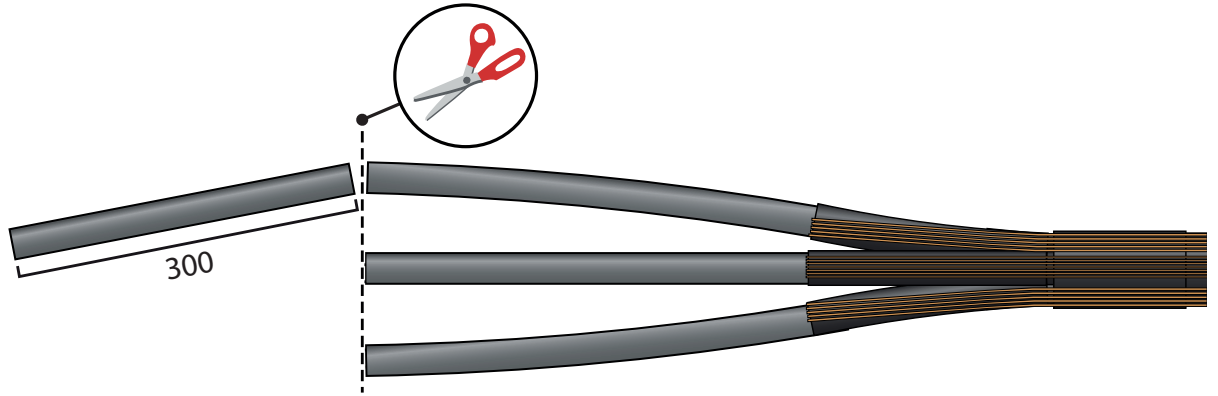

PEM-HJ11_1202C	HJ11.1202C
PEM-HJ11_2402C	HJ11.2402C
PEM-CJH11_2402C	CJH11.2402C
PEM-CJ11_2402C	CJ11.2402C

ENSTO