



## HIT1.1206

$U_o/U(U_m)$ kV	  mm <sup>2</sup>
6/10 (12) kV	630-1000





1

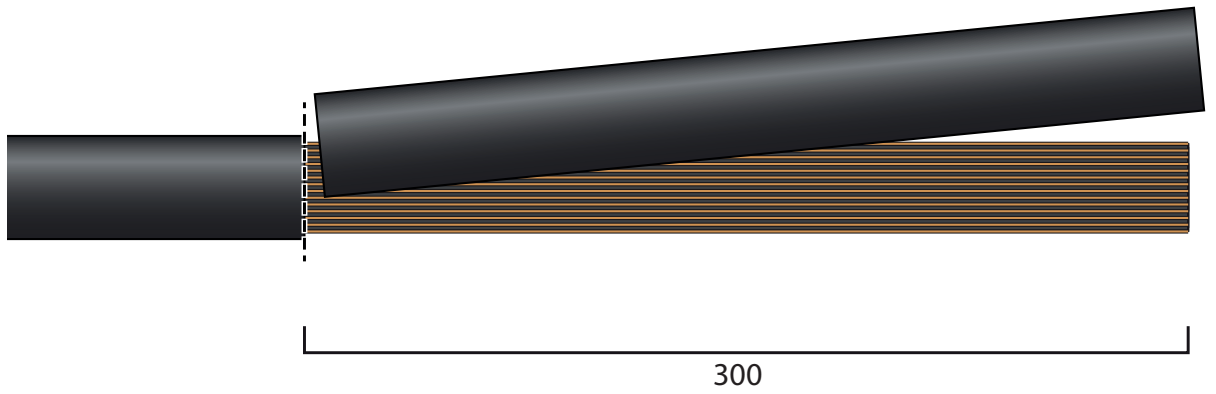

2

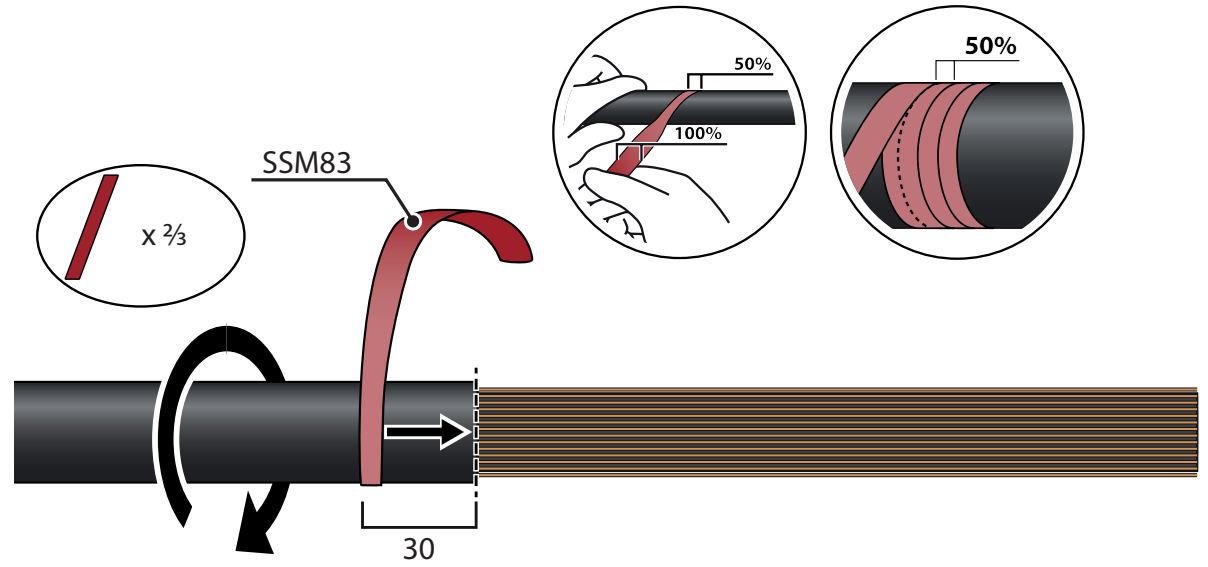

3

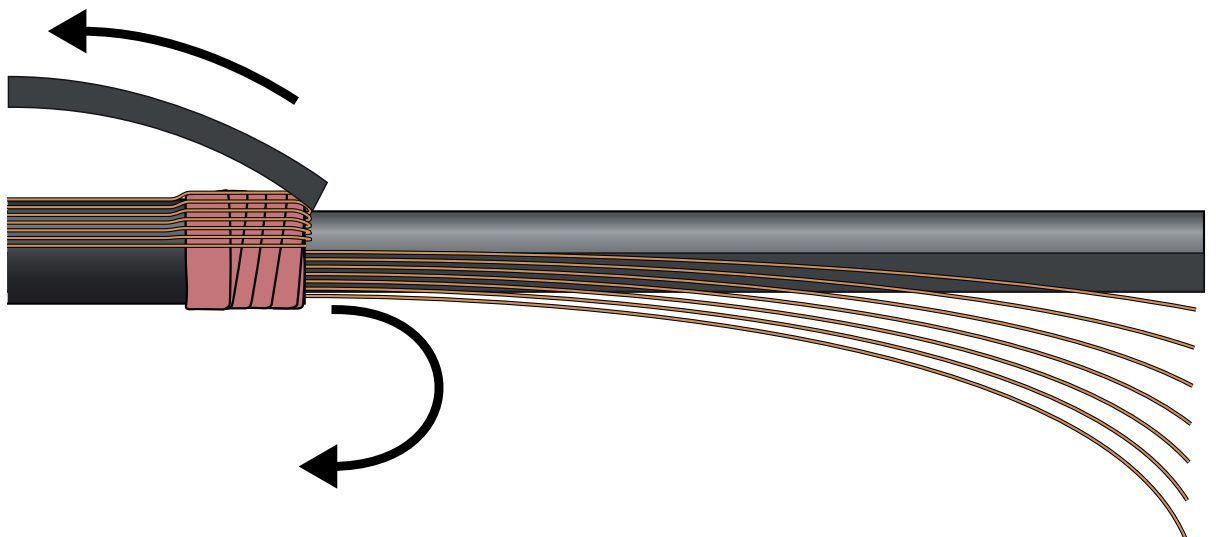

4

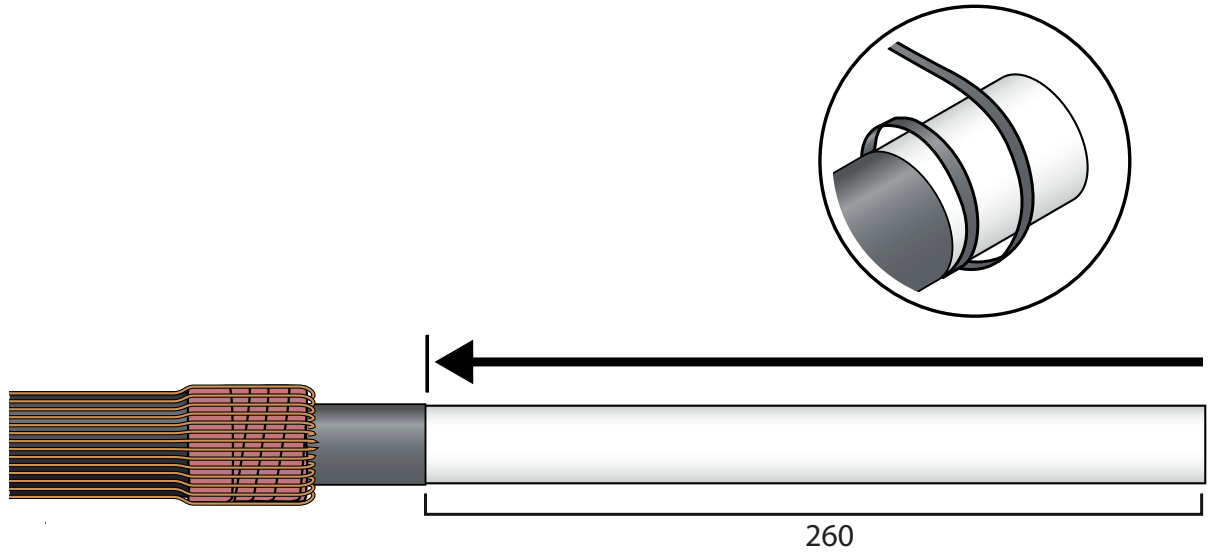

5

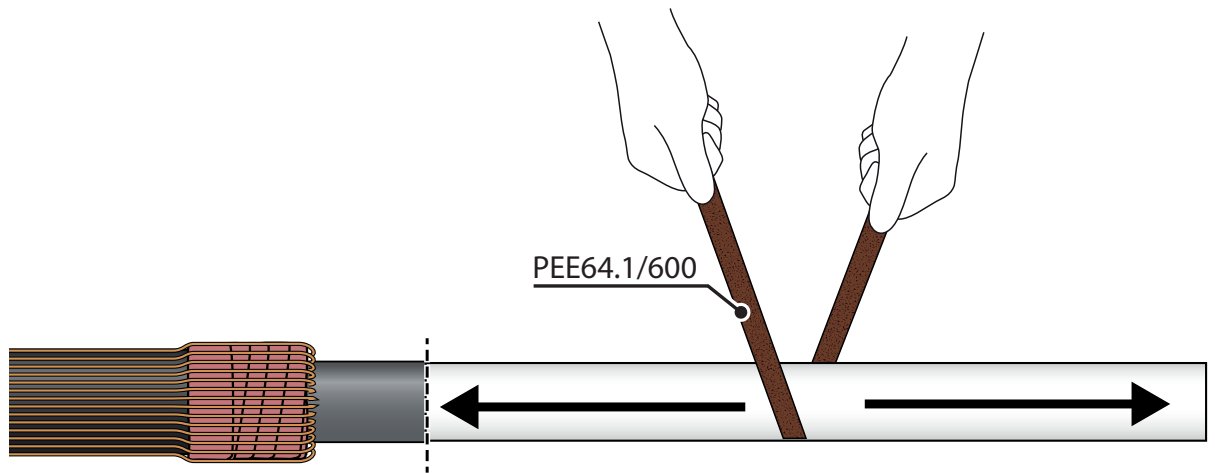
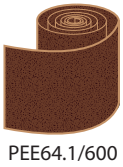

6

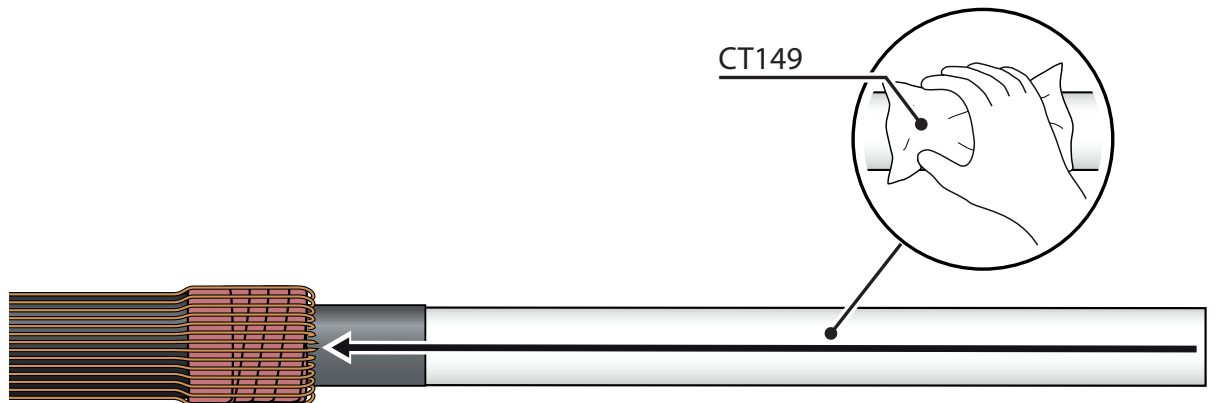
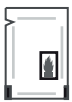

7

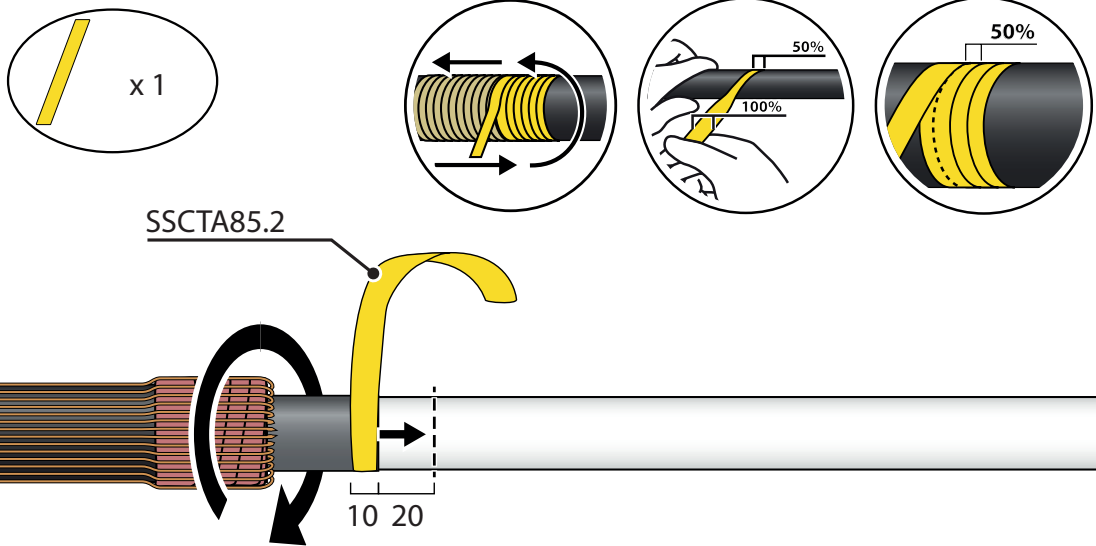

8

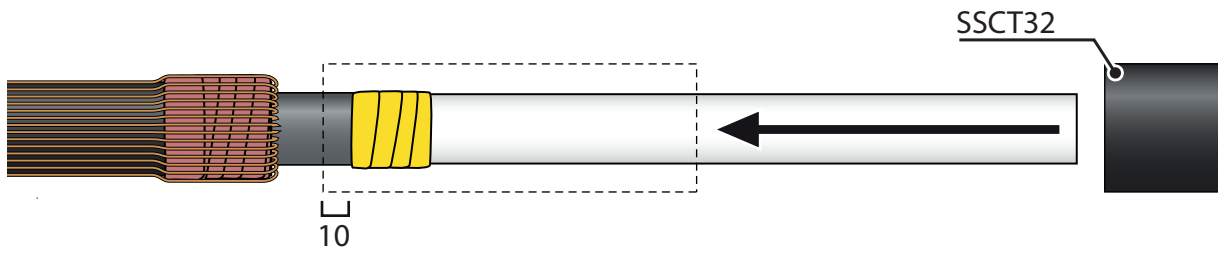
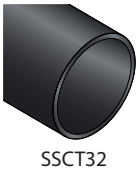

9

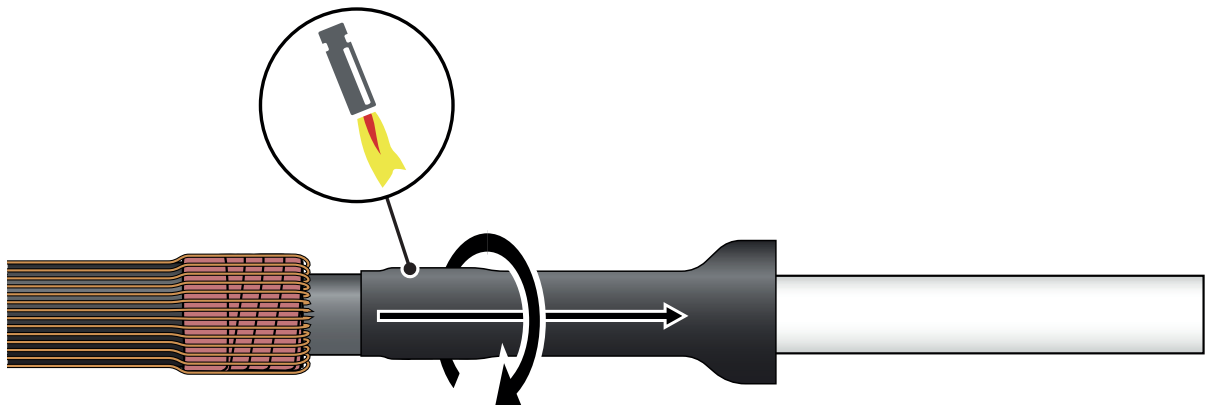

10

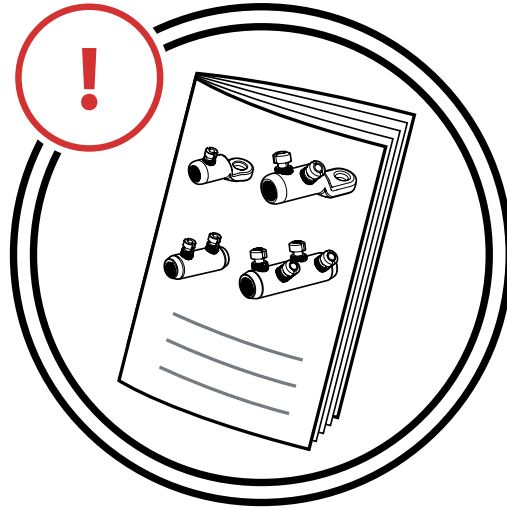

11



SSM83

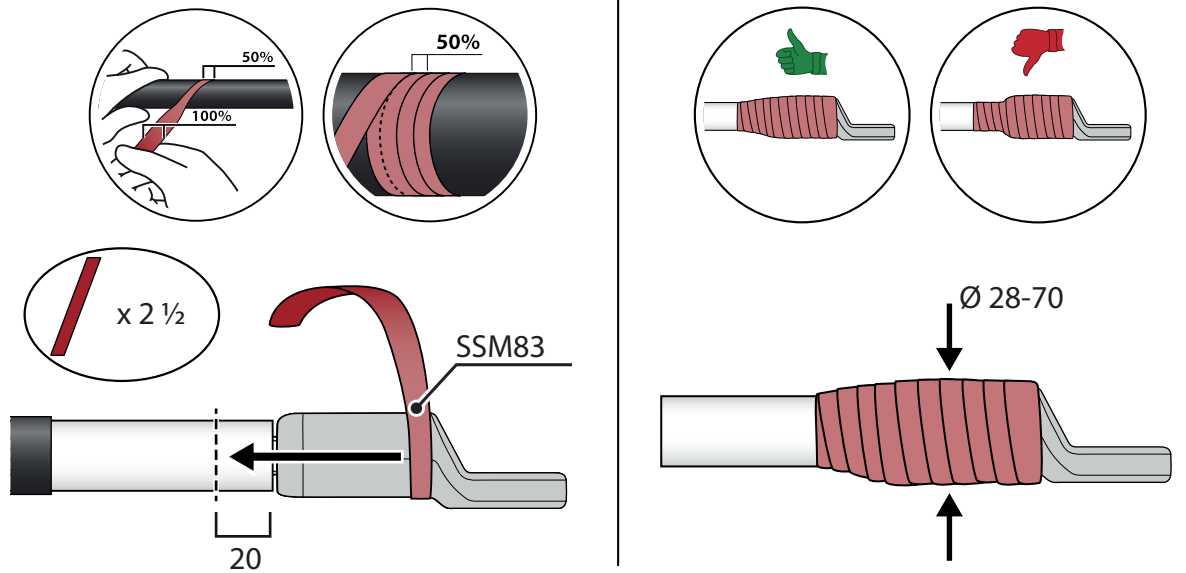

12



SSM83

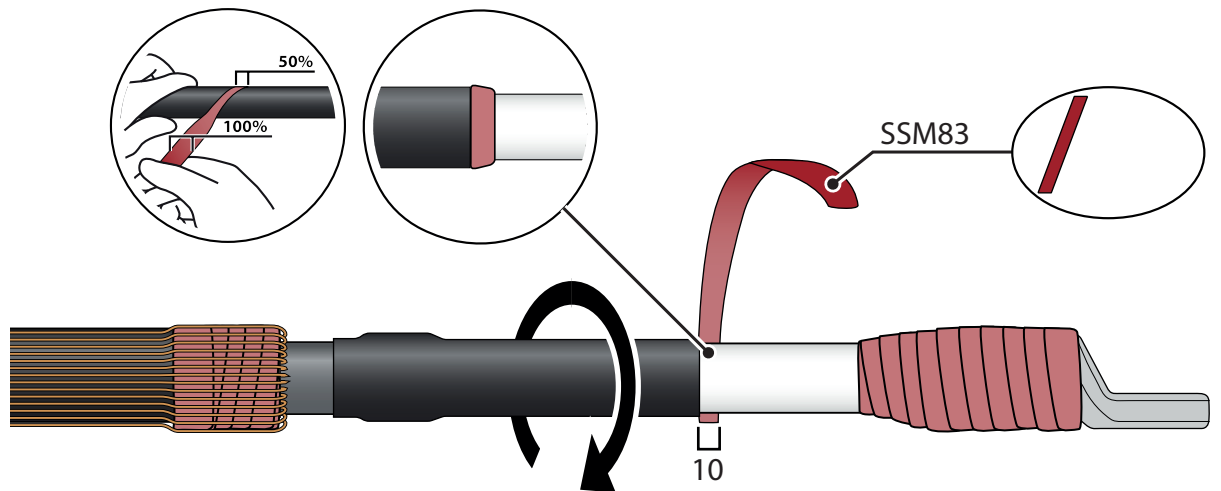

13

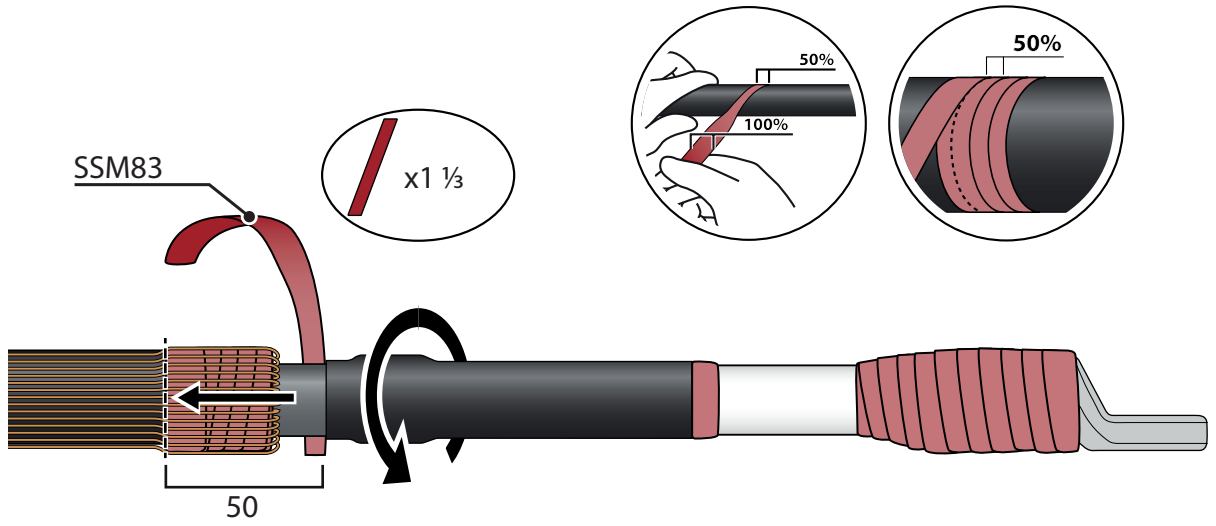

14

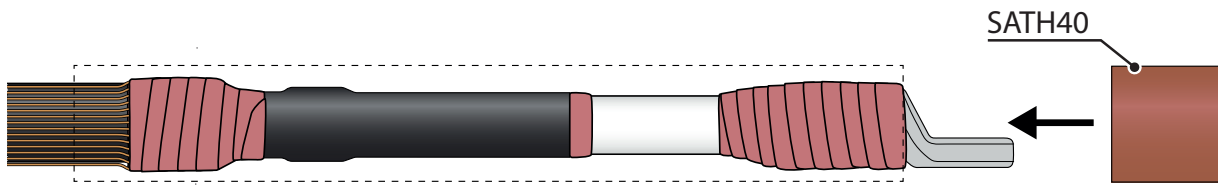
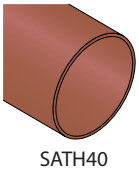

15

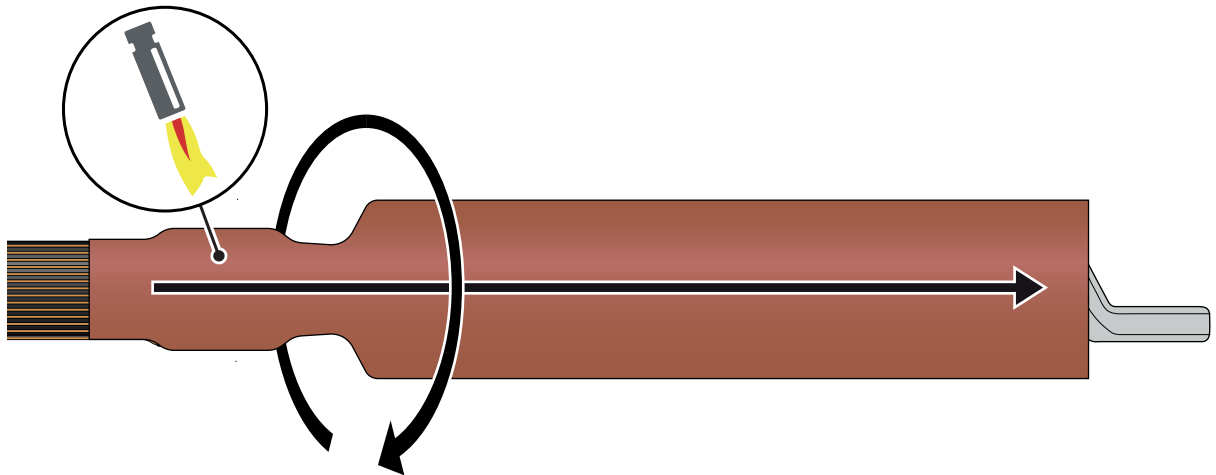



16

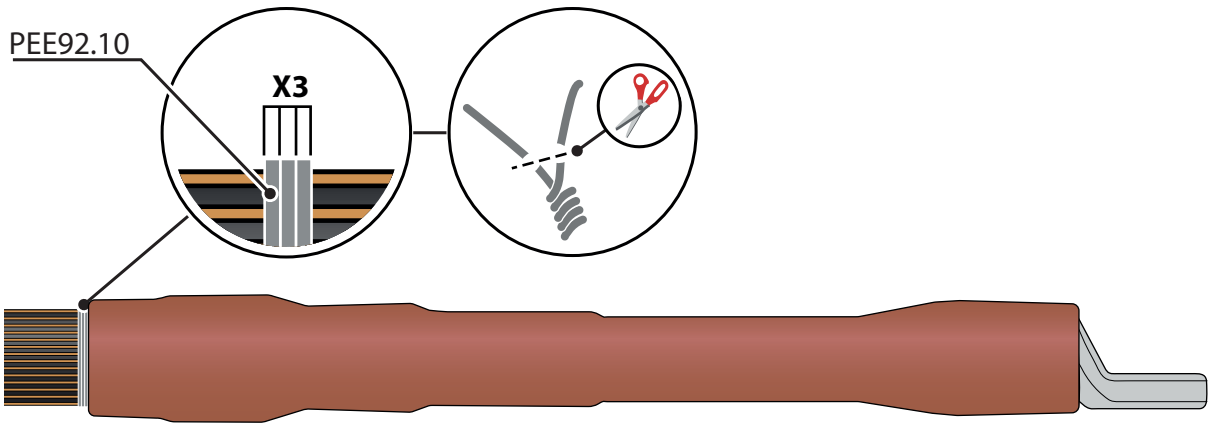

17

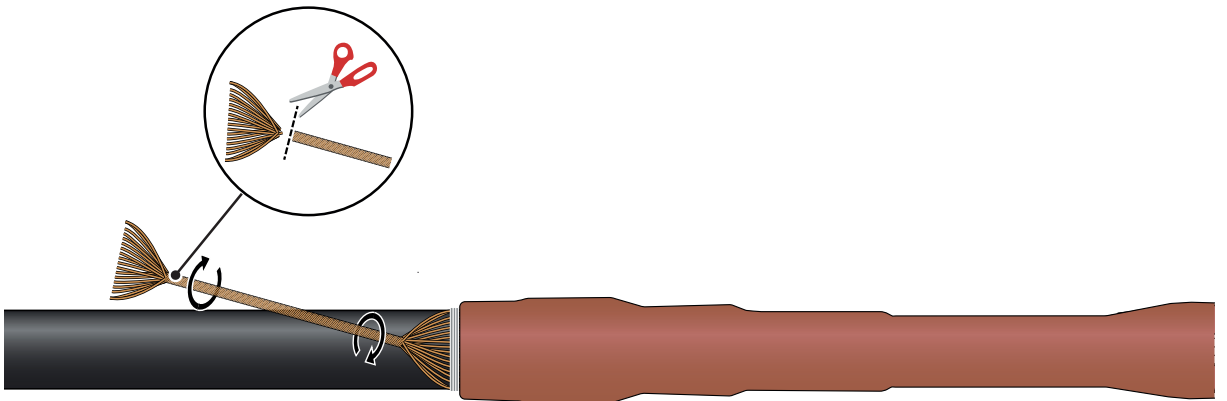

18

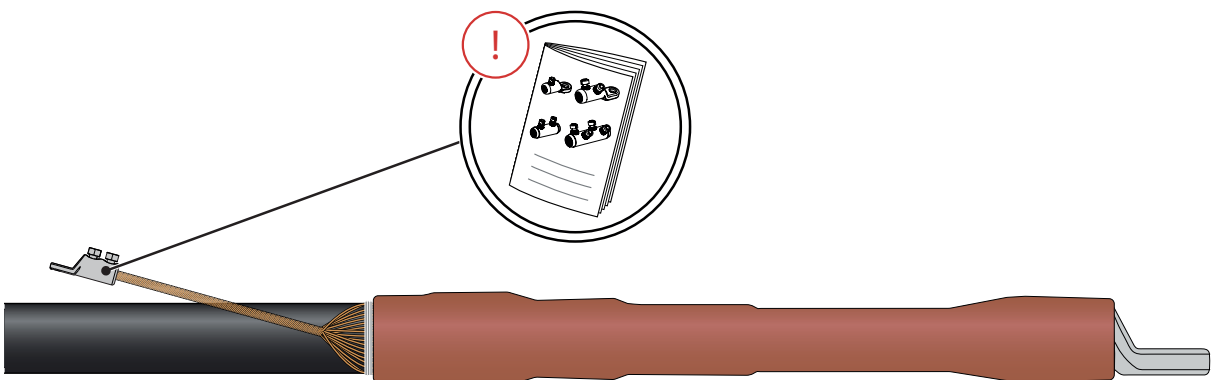

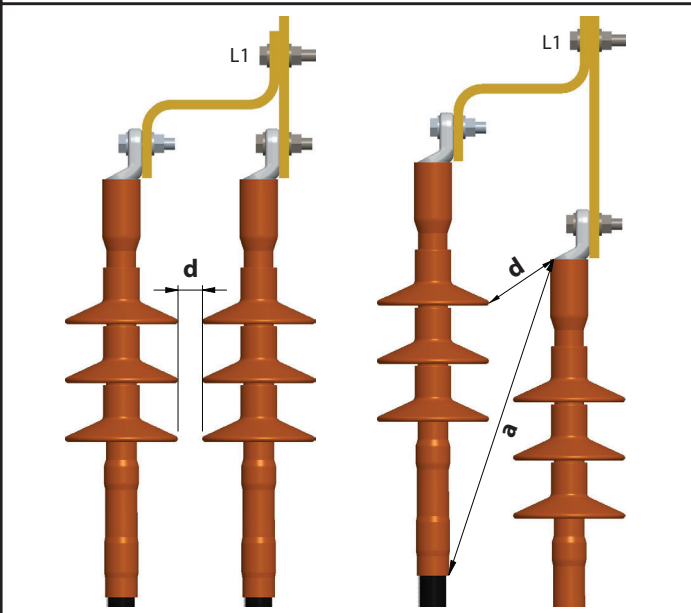
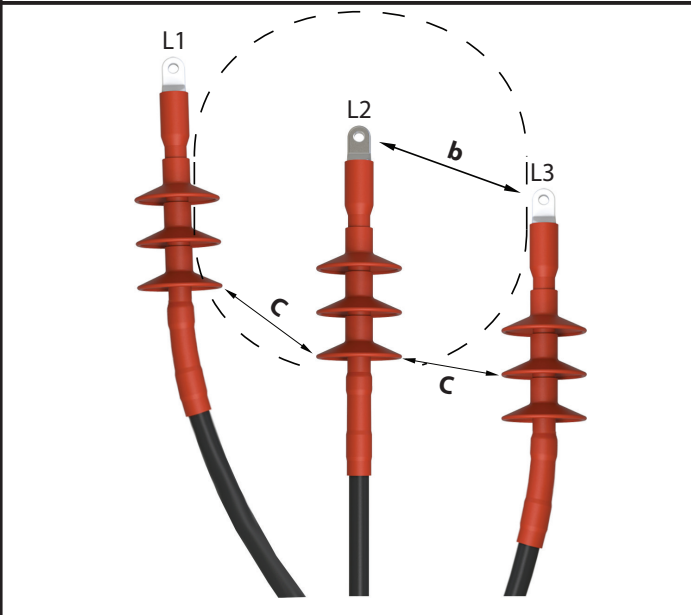
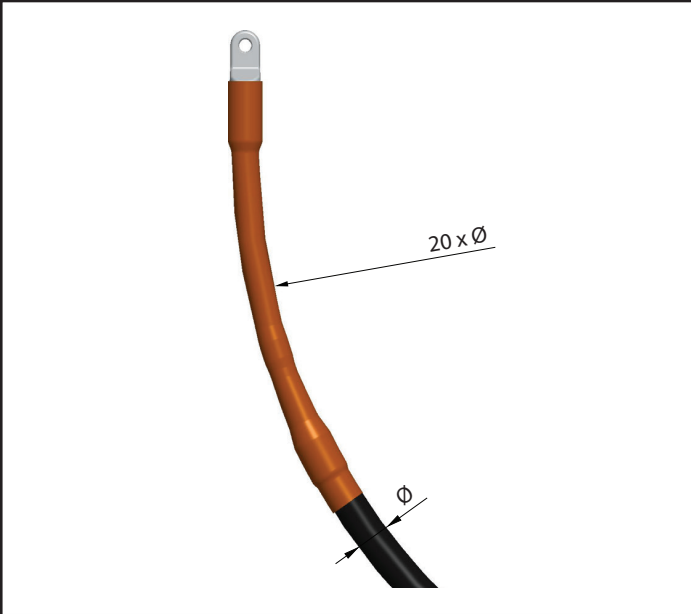
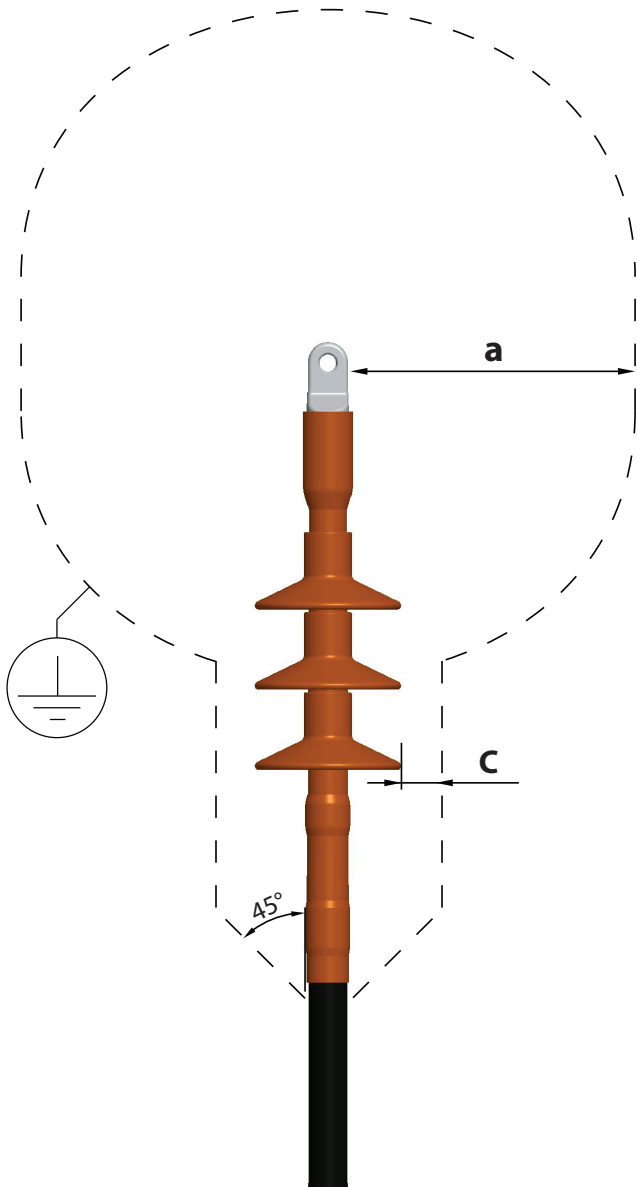

	12 kV	24 kV	36 kV
<b>a</b>	§§§	§§§	§§§
<b>b</b>	§§§	§§§	§§§
<b>c (mm)</b>	15	25	35
<b>d (mm)</b>	10	20	25

§ § § = according to local requirements



**ENSTO**