

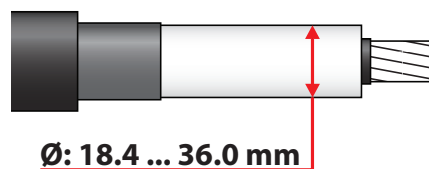







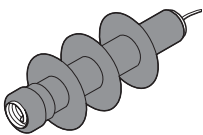
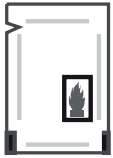
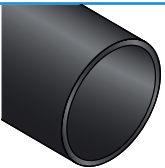
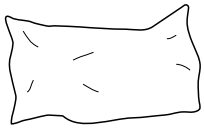
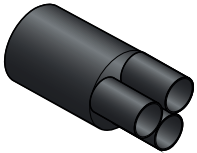

COTH31.1203L

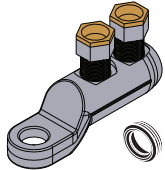
U_o/U_m (kV)	 mm^2
6.35/11 (12) kV	95-240

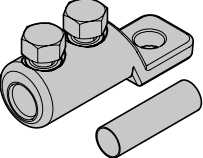

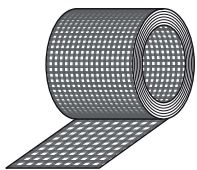
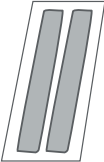
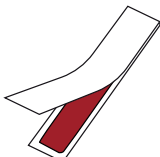
<p>(CZE) PRÁVNÍ UPOZORNĚNÍ</p> <ul style="list-style-type: none"> - Montáž výrobku smí provádět pouze k tomu způsobilá osoba s odpovídajícím proškolením, praxí a s dostatečnými znalostmi bezpečnosti a postupů instalace ve vztahu k elektrickým zařízením. Pokud místní legislativa stanoví požadavky vztahující se k takovému proškolení nebo požadovaným znalostem ohledně montáže elektrického zařízení, musí výše uvedené osoba tyto požadavky splňovat. - ENSTO nepřebírá žádnou odpovědnost ve vztahu k nárokům vyplývajícím z nesprávného použití nebo nesprávné montáže, anebo nerespektování národních předpisů bezpečnosti výrobků či jiných národních předpisů. - UPOZORNĚNÍ: Nedodržení instrukce k montáži může mít za následek poškození výrobku nebo i vážné či smrtelné zranění. 	<p>(LIT) TEISINIS PRANEŠIMAS</p> <ul style="list-style-type: none"> - Gaminį gali montuoti tik apmokytas asmuo, turintis vietos reikalavimus atitinkančią kvalifikaciją. Jei vietos įstatymai reikalauja - asmuo turi būti baigęs praktinius gaminio montavimo mokymų kursus. - Ensto neatsako už atsitiktinę, netiesioginę ar pasekmių žałą, kurią padaro šio gaminio netinkamas panaudojimas, neteisingas montavimas, saugos ar kitų nacionalinių reikalavimų nepaisymas. - DĖMESIO! Šios montavimo instrukcijos nurodymų nepaisymas gali sugadinti gaminį bei sukelti rimtą ar net mirtiną traumą. 			
<p>(DAN) VIGTIG INFORMATION</p> <ul style="list-style-type: none"> - Dette produkt må kun installeres af personer med tilstrækkelig kundskab og uddannelse indenfor installationsarbejde samt sikkerheds- og arbejdsrutiner i forbindelse med elektrisk udstyr. Såfremt lokal lovgivning omfatter bestemmelser eller anbefalinger for uddannelse eller tilstrækkelig viden vedrørende installation af elektrisk udstyr, skal sådanne bestemmelser opfyldes af disse personer. - Ensto accepterer intet erstatningsansvar i forbindelse med forkert anvendelse, fejlagtig installation af produkter eller manglende overholdelse af nationale sikkerhedsforskrifter eller øvrige bestemmelser. - ADVARSEL: Forsømmelighed i at følge instruktionen kan resultere i skade på produktet eller i værste fald alvorlig eller fatal personskade. 	<p>(NOR) JURIDISK INFORMASJON</p> <ul style="list-style-type: none"> - Produktet må bare installeres av en kompetent person med tilstrekkelig opplæring i praktisk montasje og med tilstrekkelig kunnskap om sikkerhet og installasjonspraksis i forhold til elektrisk utstyr. Hvis lokal lovgivning inneholder bestemmelser om slik opplæring, eller om å inneha tilstrekkelig kunnskap i installasjon av elektrisk utstyr, skal slike bestemmelser oppfylles av vedkommende som utfører montasjen. - Ensto tar ikke noe ansvar vedrørende krav som følge av feil bruk, feil installasjon eller ignorerte nasjonale sikkerhetsforskrifter eller andre nasjonale bestemmelser. - Advarsel: Unnlattelse av å følge installasjonsinstruksjonene kan resultere i skade på produktet og føre til alvorlige eller dødelige personskader. 			
<p>(ENG) LEGAL NOTICE</p> <ul style="list-style-type: none"> - The product must be installed only by a competent person with sufficient training in installation practices and with sufficient knowledge of good safety and installation practices in respect of electrical equipment. If local legislation contains provisions in respect of such training or sufficient knowledge in respect of installation of electrical equipment such provisions shall be fulfilled by the said person. - Ensto accepts no liability concerning claims resulting from misuse, incorrect installation or ignored national safety regulations or other national provisions. - WARNING: Failure to follow the installation instructions may result in damage to the product and serious or fatal injury. 	<p>(POL) POUCENIENIE</p> <ul style="list-style-type: none"> - Produkt powinien zostać zainstalowany przez wykwalifikowaną osobę, posiadającą stosowne doświadczenie i wiedzę w zakresie zasad bezpieczeństwa oraz instalacji sprzętu elektrycznego. O ile miejscowe przepisy zawierają postanowienia dotyczące wymogu posiadania doświadczenia, bądź niezbędnej wiedzy w zakresie instalacji urządzeń elektrycznych, postanowienia te powinny zostać wypełnione przez wspomnianą powyżej osobę. - Ensto nie ponosi żadnej odpowiedzialności za niewłaściwe korzystanie, nieprawidłową instalację lub naruszenie regulacji krajowych dotyczących bezpieczeństwa, bądź innych krajowych przepisów prawnych. - OSTRZEŻENIE: wykonanie instalacji w sposób niezgodny z instrukcją może skutkować uszkodzeniem produktu i poważnymi lub śmiertelnymi obrażeniami ciała. 			
<p>(EST) JURIDILINE MÄRKUS</p> <ul style="list-style-type: none"> - Seda toode toimib paigaldada ainult pädev, paigaldustöödes piisavalt väljaõpet omav isik, kellel on piisavad teadmised elektriseadmete turva- ja paigaldustavadest. Kui kohalik seadusandlus või võrguettevõtja kehtestatud eeskiri sisaldab nõudeid niisuguse väljaõppe või elektriseadmete paigaldamiseks piisavate teadmiste kohta, peab paigaldaja neile nõudmistele vastama. - Ensto ei vastuta nõuete eest, mis tulenevad väärkasutusest, ebaõigest paigaldusest või kehtivate turva- või muude reeglite eiramisest. - HOIATUS: paigaldusjuhiste järgimata jätmine võib kaasa tuua toote kahjustumise ja tõsise või surmava vigastuse. 	<p>(POR) AVISO LEGAL</p> <ul style="list-style-type: none"> - Este acessório só deverá ser instalado por pessoal especializado, com suficiente formação neste tipo de trabalho, familiarizado com equipamentos eléctricos e aplicação das regras de segurança. Se a legislação local exigir formação ou treino adicional, é da responsabilidade do operador cumprir esses requisitos. - A Ensto e a RESUL não assumem responsabilidades relativas a reclamações originadas por mau uso, instalação incorrecta ou desconhecimento de regulamentos de segurança ou outra legislação. - AVISO: A falha em seguir as instruções de montagem pode resultar em danos no acessório e ferimentos graves ou fatais. 			
<p>(FIN) OIKEUDELLINEN ILMOITUS</p> <ul style="list-style-type: none"> - Tuotteen asennuksen saa suorittaa vain ammattitaitoinen henkilö, jolla on riittävät tiedot sähkölaitteiden asentamisesta ja sähköturvallisuudesta. Asennus tulee suorittaa voimassa olevia säädköksiä noudattaen. Lisäksi asennuksen suorittajan tulee täyttää kansallisen lainsäädännön asettamat pätevyysvaatimukset. - Ensto ei vastaa vrioista, jotka aiheutuvat tuotteen virheellisestä käytöstä, väärästä asennustavasta tai kansallisten turvallisuusmääräysten noudattamatta jättämisestä. - VAROITUS! Asennusohjeiden vastainen asennus voi johtaa tuotteen vahingoittumiseen tai vaka-vaan onnettomuuteen. 	<p>(RON) AVIZ JURIDIC</p> <ul style="list-style-type: none"> - Produsul trebuie instalat numai de către o persoană competentă, cu pregătire suficientă în practice de instalare și cu cunoștințe suficiente de bune în practici de siguranță și de instalare în ceea ce privește echipamentele electrice. În cazul în care legislația locală conține dispoziții cu privire la o astfel de formare sau cunoștințe suficiente în ceea ce privește instalarea de echipamente electrice, aceste dispoziții vor fi îndeplinite de către persoana respectivă. - A Ensto e a RESUL nu își asumă nici o responsabilitate în ceea ce privește reclamațiile rezultate din utilizarea necorespunzătoare, instalarea incorectă sau ignorarea reglementărilor naționale de siguranță sau a altor dispoziții naționale. - AVERTIZARE: Nerespectarea instrucțiunilor de instalare poate duce la deteriorarea produsului și accidente grave sau mortale. 			
<p>(FRA) MENTIONS LÉGALES</p> <ul style="list-style-type: none"> - Seules des personnes formées et habilitées aux travaux sous tension BT peuvent mettre en oeuvre ce matériel sur un réseau sous tension. Le port des EPI adaptés et le respect des Conditions d'Exécution du Travail sous tension BT est de la responsabilité de l'opérateur. Le non-respect des instructions d'installation peut provoquer un endommagement du produit et des blessures graves, voire mortelles. - Ensto n'assume aucune responsabilité quant à des réclamations découlant d'une mauvaise utilisation, d'une installation incorrecte ou d'une méconnaissance des règlements nationaux de sécurité. 	<p>(RUS) ПРАВОВОЕ УВЕДОМЛЕНИЕ</p> <ul style="list-style-type: none"> - Изделие должно быть установлено только компетентным человеком, имеющим соответствующую профессиональную подготовку и знающим технику безопасности. Если местное законодательство требует сдачи соответствующих нормативов и прохождения курсов подготовки для допуска к работе, то эти условия должны подлежать обязательному персональному выполнению. - Ensto не несет ответственность за последствия при неправильном использовании, установке или игнорировании правил техники безопасности или других местных положений. - ПРЕДУПРЕЖДЕНИЕ: Несоблюдение инструкций по установке может привести к повреждению изделия и к серьезной или даже фатальной травме. 			
<p>(GER) RECHTLICHER HINWEIS</p> <ul style="list-style-type: none"> - Das Produkt darf nur von kompetent und entsprechend geschulten Fachleuten installiert werden, die über ausreichende Kenntnisse im Arbeitsschutz und in der Elektroinstallation verfügen. Wenn das lokale Recht Bestimmungen hinsichtlich der Schulungen und Kenntnisse bei Elektroinstallation enthält, muss die entsprechende Person diese Bestimmungen erfüllen. - Ensto übernimmt keine Haftung für Ansprüche, die auf Fehlgebrauch, fehlerhafte Montage oder die Nichtbeachtung nationaler Sicherheitsvorschriften oder anderer nationaler Bestimmungen zurückzuführen sind. - ACHTUNG: Die Nichtbeachtung der Montageanweisungen kann Produktschäden und schwere oder sogar tödliche Verletzungen zur Folge haben. 	<p>(SLK) PRÁVNA STRÁNKA MONTÁŽE</p> <ul style="list-style-type: none"> - Montáž výrobku smie vykonávať len kompetentná osoba s adekvátnym tréningom, praxou a s dostatočnými znalosťami bezpečnosti práce vzhľadom k prislúšnému vybaveniu elektrického zariadenia a priestorom. Ak miestna legislatíva obsahuje nariadenia takých tréningov alebo požiadaviek na dostatočné vedomosti s ohľadom na inštalácie týkajúci sa elektrického zariadenia, tak tieto opatrenia budú vykonávané u tejto osoby. - ENSTO neakceptuje žiadnu zodpovednosť týkajúcu sa nárokov vyplývajúcich z nesprávneho použitia, nesprávnej montáže alebo ignorovania národných bezpečnostných pravidiel alebo iných národných nariadení. - UPOZORNĚNÍ: Nedodržanie postupu montážneho návodu môže mať za následok poškodenia výrobku alebo i vážne zranenia. 			
<p>(HUN) JOGI NYILATKOZAT</p> <ul style="list-style-type: none"> - Ezt a terméket csak olyan szakember szerelheti, aki részt vett a megfelelő elméleti, gyakorlati és biztonságtechnikai oktatáson, hálózatépítő szerelői tanfolyamon. Amennyiben a helyi szabályok megkövetelnek további képzettséget vagy szakmai tudást, úgy a szerelést végzőnek a fentiekben tülbemőnd ezeket is meg kell felennie. - Az Ensto nem vállal felelősséget a nem rendeltetésszerű használatból, helytelen vagy nem szakszerű szerelésből, az esetleges nemzeti biztonsági előírások figyelmen kívül hagyásából eredő károkért és következményekért. - FIGYELEM: a szerelési utasítások megsértése a termék sérüléséhez vezethet, illetve súlyos vagy végzetes sérülést okozhat! 	<p>(SLV) PRAVNO OBVESTILO</p> <ul style="list-style-type: none"> - Proizvod lahko vgradi le strokovno usposobljena in pooblašena oseba z zadostnim znanjem v procesih vgradnje, varstvu pri delu in montaži električne opreme. Če lokalna zakonodaja vsebuje določbe v zvezi s takšnim usposabljanjem in zadostnim znanjem vgradnje električne opreme morajo biti te določbe izpolnjene s strani omenjene osebe. - Podjetje Ensto ne prevzema nobenih odgovornosti v zvezi z zahtevki, ki so posledica napačne uporabe, nepravilne vgradnje ali zanemarjanja nacionalnih varnostnih predpisov in drugih določb. - OPOZORILLO: Neupoštevanje navodil za namestitve lahko povzroči poškodbe izdelka in posledično nevarnost resnih telesnih ali smrtnih poškodb. 			
<p>(ITA) NOTE LEGALI</p> <ul style="list-style-type: none"> - Il prodotto deve essere installato esclusivamente da persona competente con sufficiente formazione nelle pratiche di installazione e con sufficiente conoscenza delle norme di sicurezza e delle procedure di installazione per le apparecchiature elettriche. Qualora la legislazione locale preveda disposizioni relativamente a tale formazione o sufficiente conoscenza per quanto riguarda la installazione di apparecchiature elettriche, tali disposizioni dovranno essere adempiute da detta persona. - Ensto non accetta nessuna responsabilità riguardo eventuali danni derivanti da uso improprio, installazione non corretta o che non rispetti le norme di sicurezza o altre disposizioni nazionali. - ATTENZIONE: La non osservanza delle istruzioni per l'installazione può causare danni al prodotto e lesioni gravi o fatali. 	<p>(SPA) AVISOS LEGALES</p> <ul style="list-style-type: none"> - El producto debe ser instalado sólo por una persona competente con capacitación suficiente en prácticas de instalación y con conocimiento suficiente de las normativas de seguridad adecuadas con respecto al equipamiento eléctrico. Si la legislación local contiene disposiciones con respecto a dicha capacitación o conocimiento suficiente con respecto a la instalación del equipo eléctrico dicha persona deberá cumplir con tales disposiciones. - Ensto no acepta ninguna responsabilidad con respecto a los reclamos que resultan del uso indebido, instalación incorrecta o regulaciones de seguridad nacional ignoradas u otras disposiciones nacionales. - ADVERTENCIA: No seguir las instrucciones de instalación podría resultar en un daño al producto y lesión grave o fatal. 			
<p>(LAT) ATRUNA</p> <ul style="list-style-type: none"> - Produktu drīkst uzstādīt tikai attiecīgi kvalificēta persona, kura ir pietiekami labi apmācīta veikt šādu uzstādīšanu un kura ir pietiekami zināša par drošības tehnikas noteikumiem un uzstādīšanas kārtību darbā ar elektroierīcēm. Ja nacionālie normatīvie akti paredz prasības vai īpašus noteikumus attiecībā uz šādu apmācību vai nepieciešamajām zināšanām darbā ar elektroierīcēm, tad minētajai personai šīs prasības un noteikumi ir jāievēro. - Ensto neuzņemas nekādu atbildību par prasījumiem, kas cēlušies no nepareizas lietošanas, nepareizas uzstādīšanas, nacionālo drošības noteikumu vai citu noteikumu neievērošanas. - UZMANĪBU: Uzstādīšanas instrukciju neievērošana var radīt kaitējumu produktam vai radīt smagus vai nāvējošus ievainojumus. 	<p>(SWE) VIKTIG INFORMATION</p> <ul style="list-style-type: none"> - Denna produkt får endast installeras av person med erforderlig kunskap och utbildning avseende installationsarbete och säkerhets- och installationsfrågor beträffande elektrisk utrustning. Om tillämplig lagstiftning eller gällande föreskrifter innehåller bestämmelser eller rekommendationer beträffande sådan kunskap och utbildning eller behörighetskrav med avseende på installation av elektrisk utrustning skall vad som härvid föreskrivs tillämpas med avseende på den som utför installationen. Vid tvëksamhet om vad som gäller kontrollera med fackkunskap. - Ensto friskriver sig från allt ansvar beträffande krav i anledning av felaktig användning eller felaktig installation av produkten eller underlåtenhet att iaktta lokala säkerhetsföreskrifter eller andra tillämpliga bestämmelser eller rekommendationer. - VARNING: underlåtenhet att följa instruktionerna avseende installation kan resultera i skada på produkten och även allvarlig skada på person eller dödsfall. 			
ENSTO FINLAND OY ENSIO MIETTISEN KATU 2, P.O.BOX 77	06101 PORVOO, FINLAND	TEL. +358 204 76 21	EMAIL: ENSTO@ENSTO.COM	WWW.ENSTO.COM

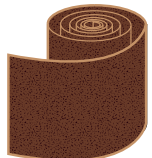
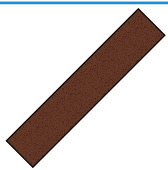
	CTSAGEL16-45L		3		CT149	3
	CPEEPL51-16	1000 mm	6		PA23	1
	SBO3.4		1		PEE39/1500	1
	LA240N13SB2		3		PEE225W	1
	LUG6-50/12LVTIN		3		PEM-COTH31.1203L	1
	STCTA49.7	7000 mm	3			
	SMG200	2x100 mm	6			
	SSM83.3	1x360 mm	4			
 	MPA21 RFL15		3 3			
	PEE64.1	600 mm	2			
	PEE64	150 mm	1			

1

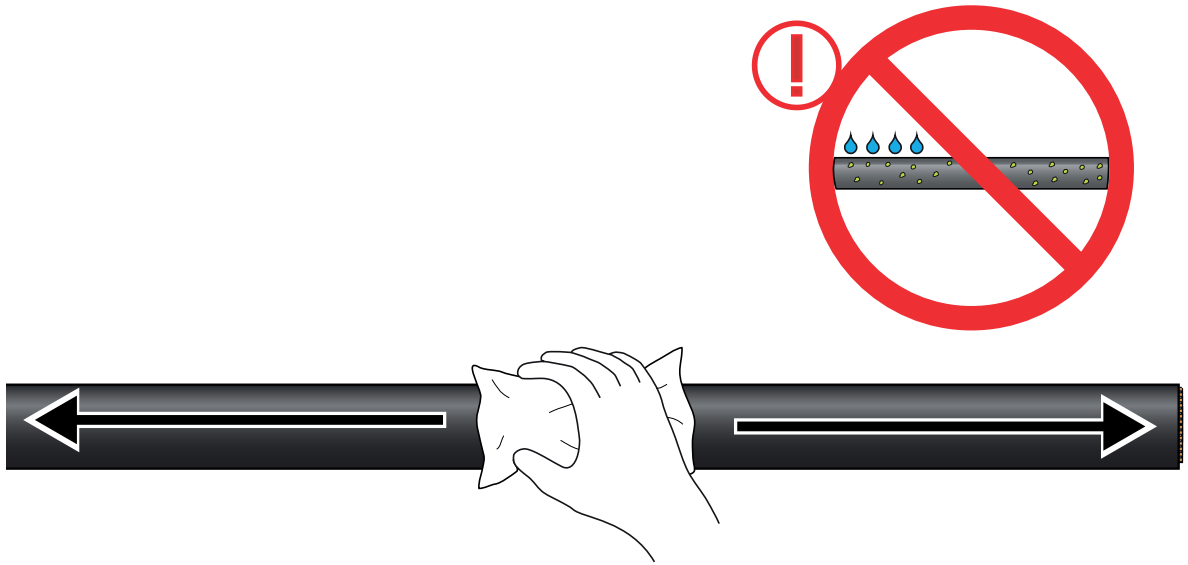

2

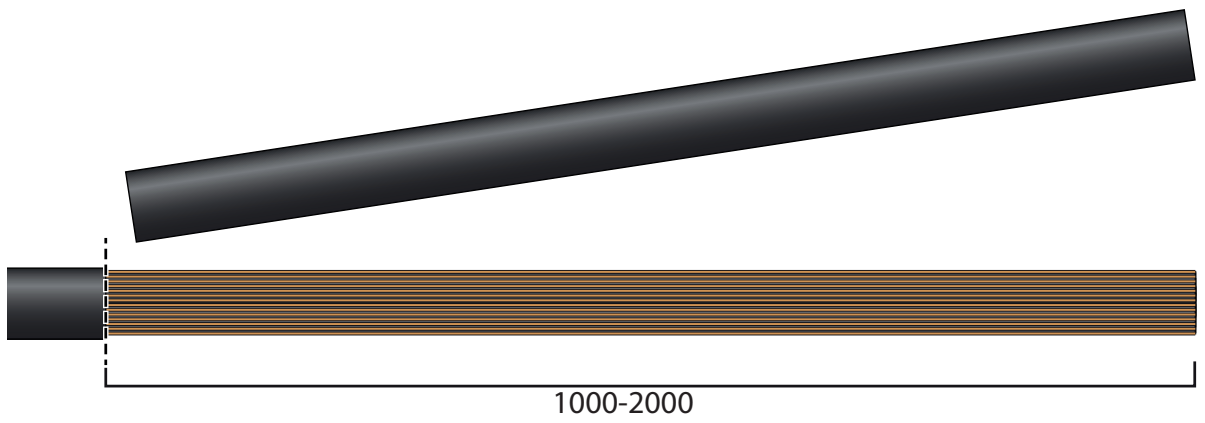

3

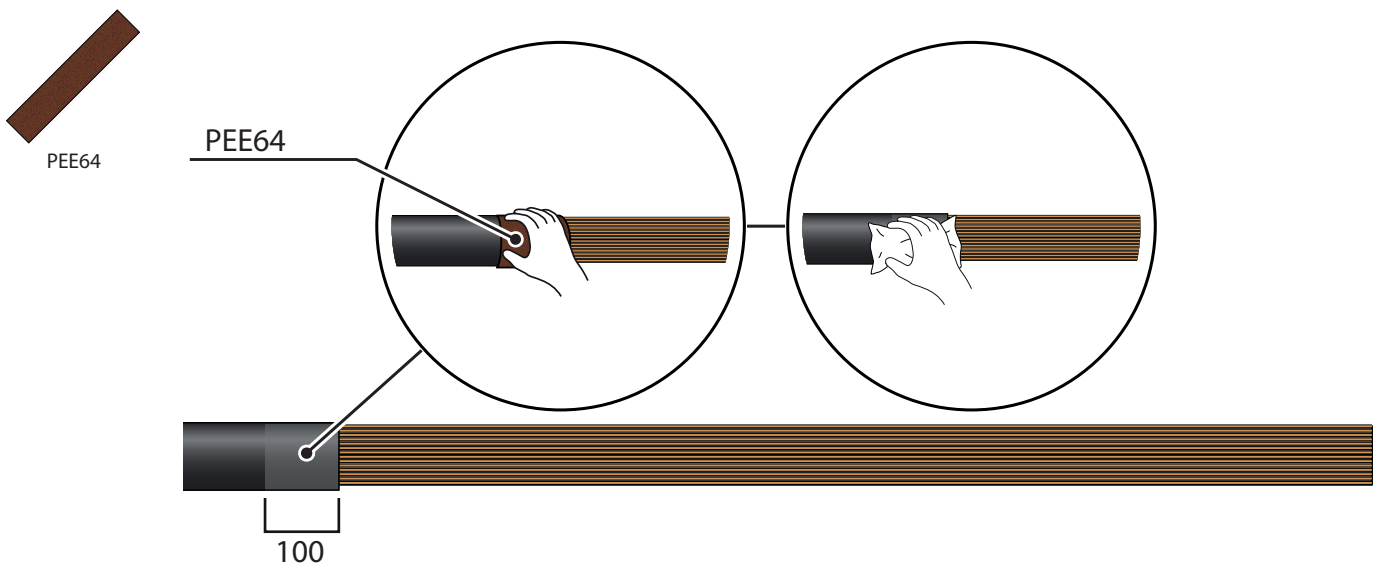

4

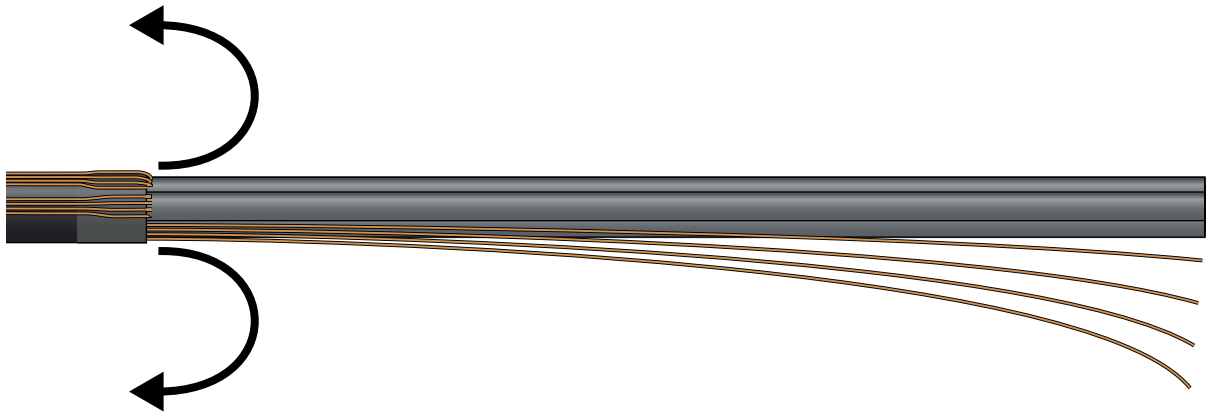

5

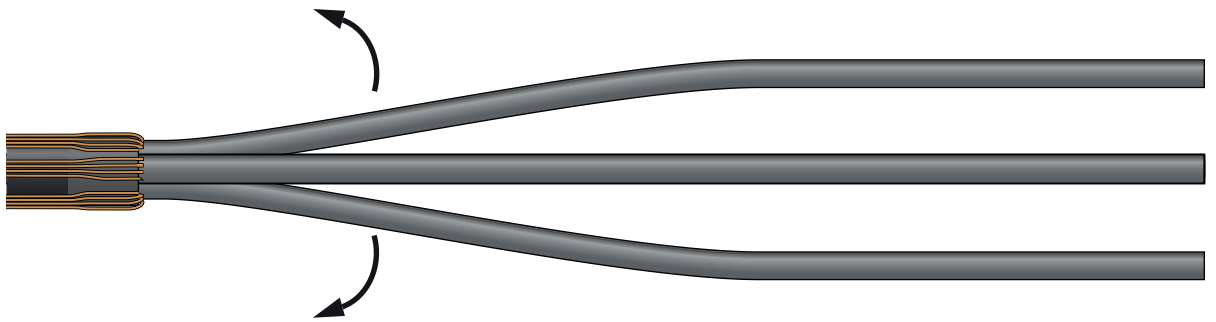

6

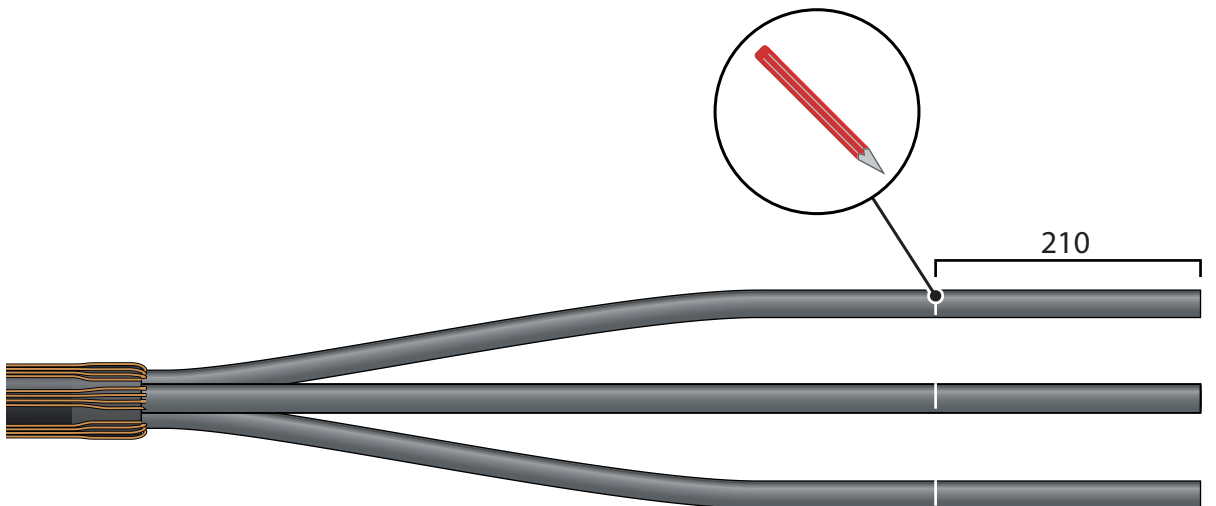

7

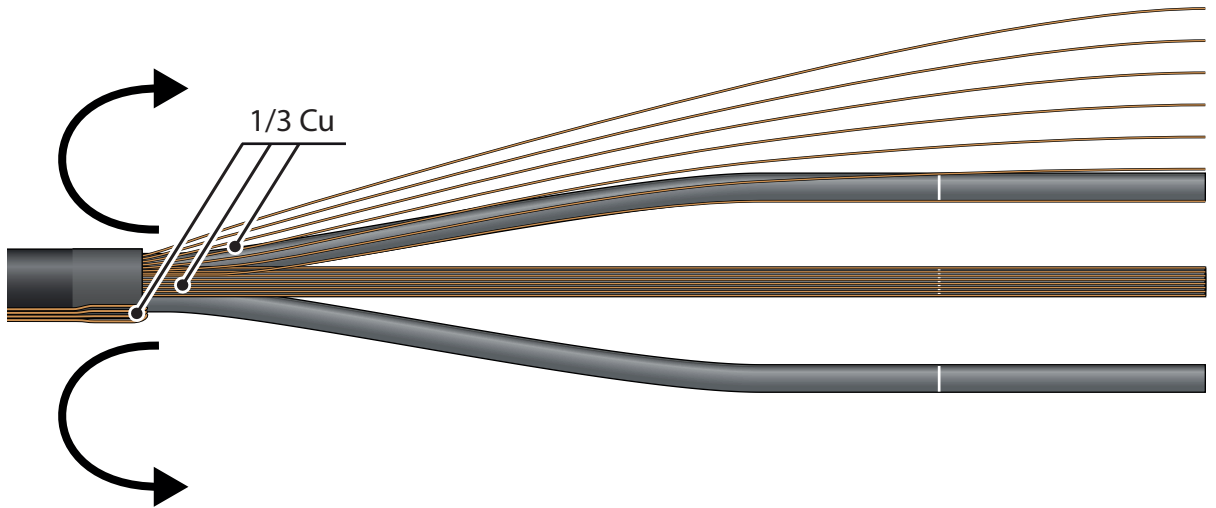

8

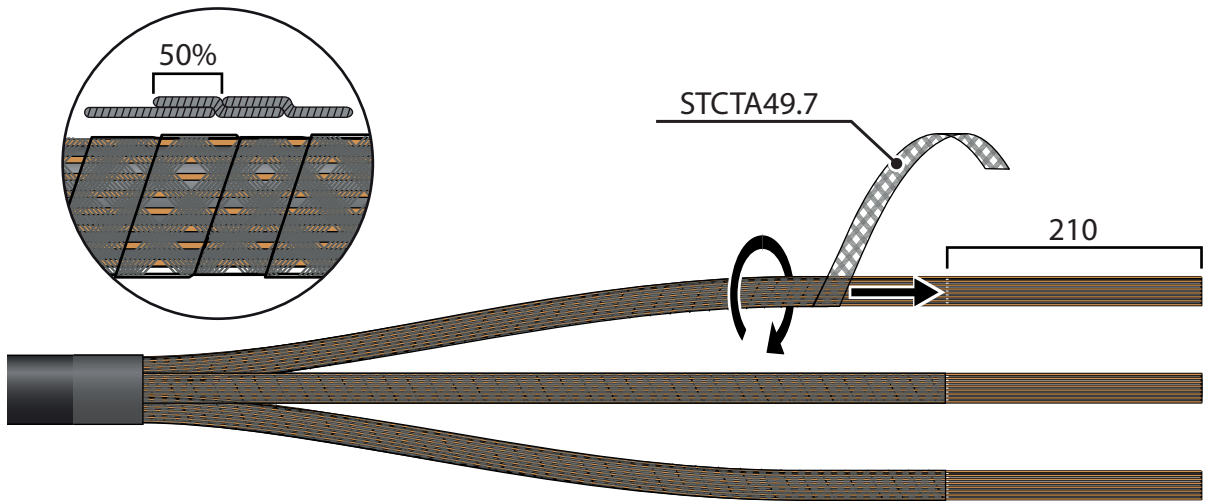

9

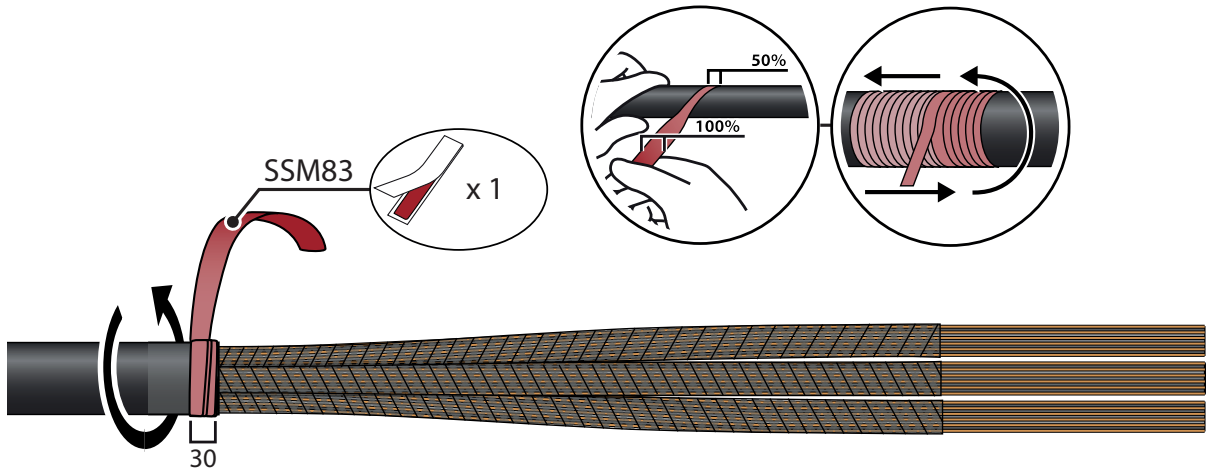

10



SBO3.4

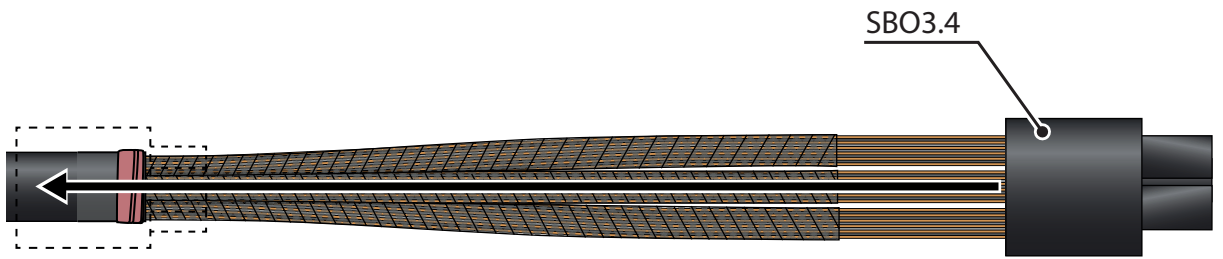

SBO3.4

11

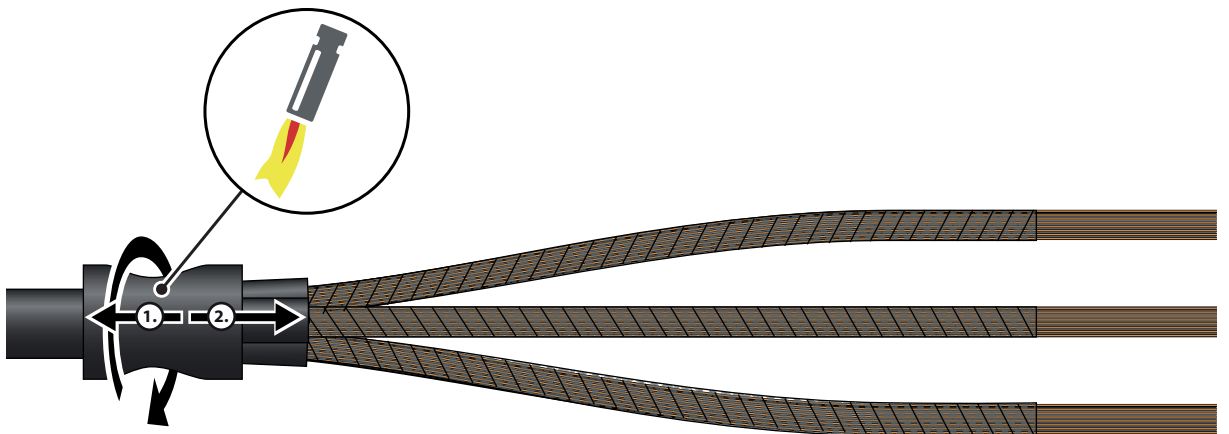

12

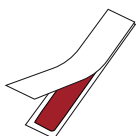

SSM83

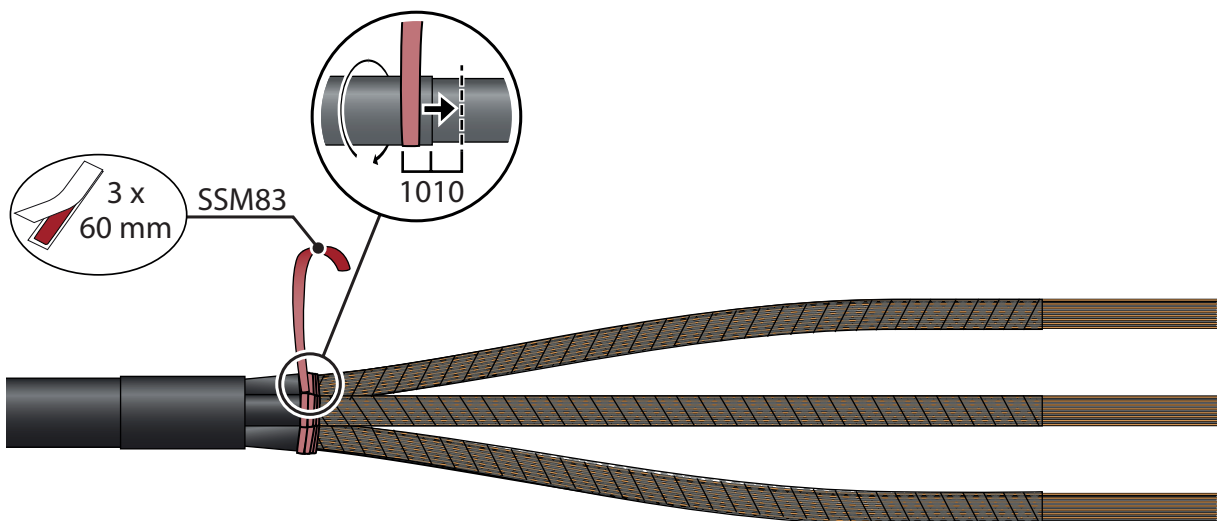

3 x
60 mm

SSM83

1010

13

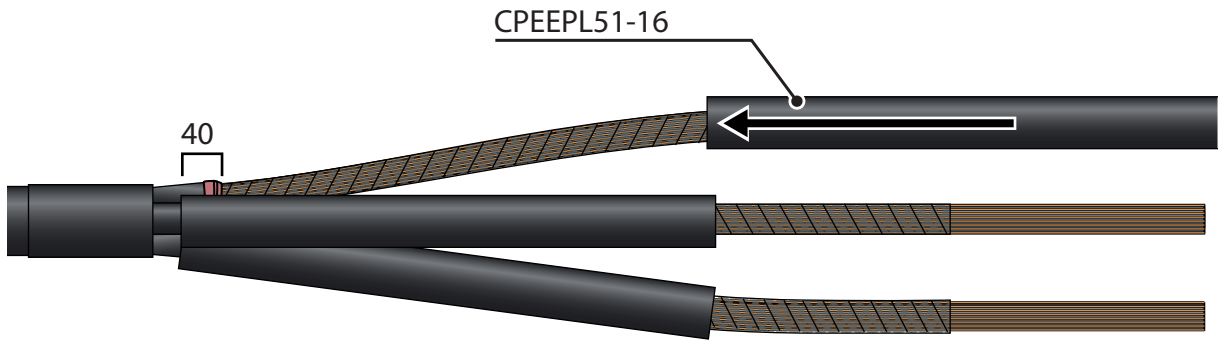
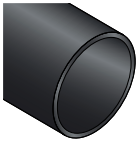

14

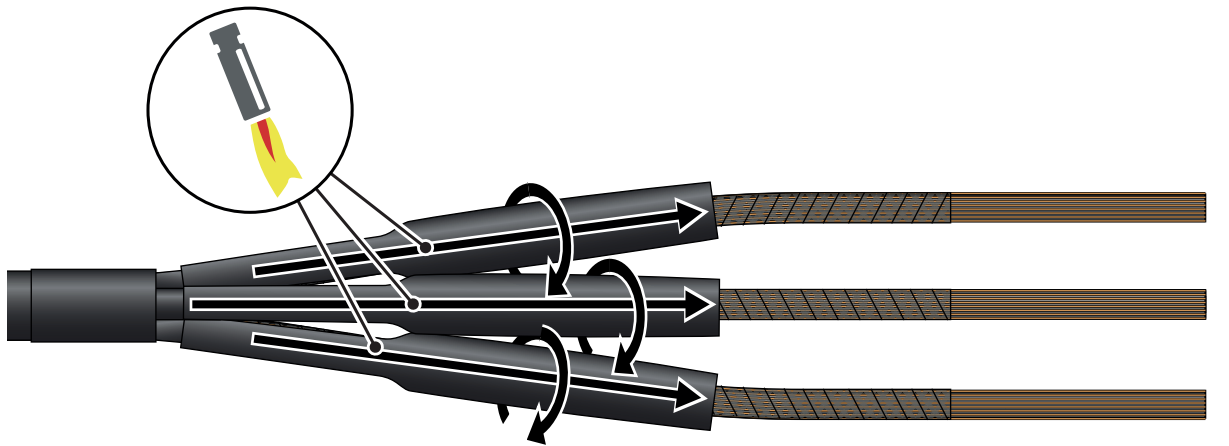

15

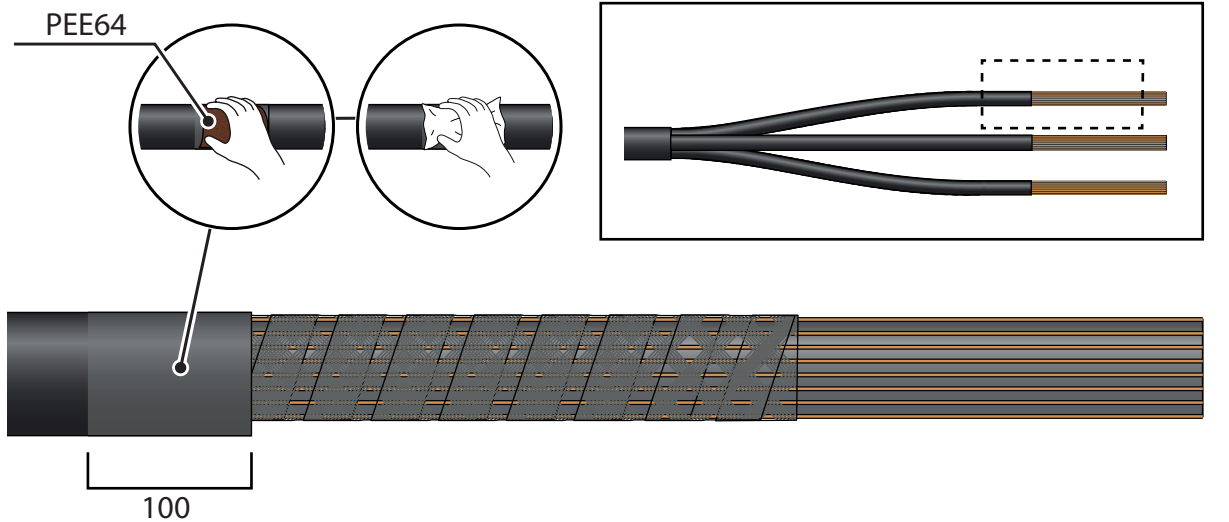

16

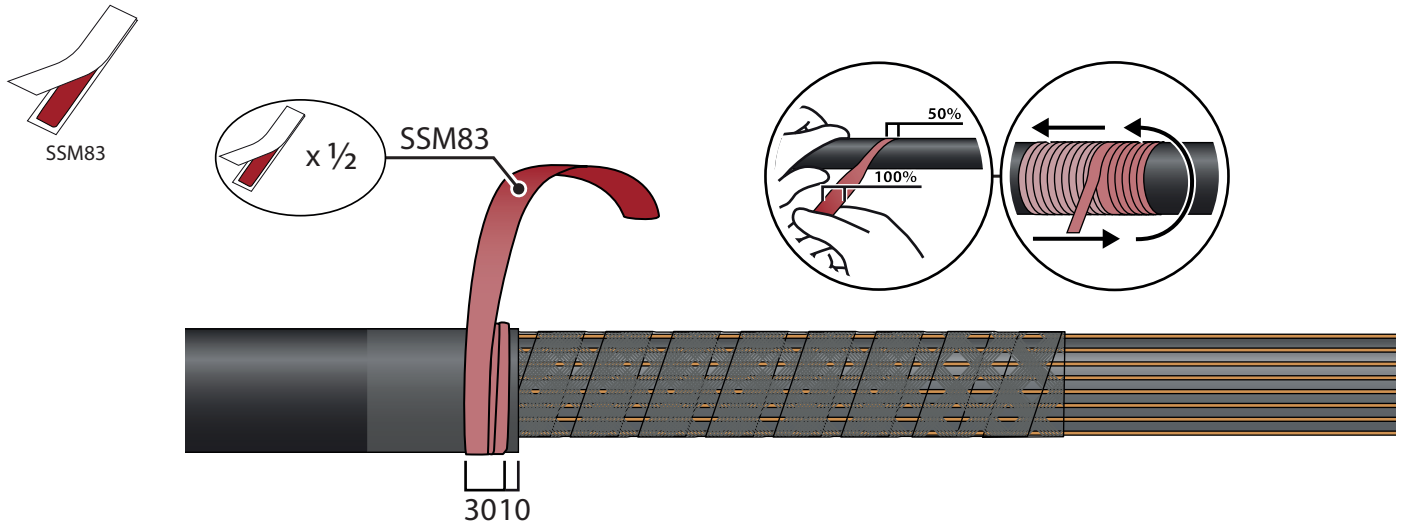

17

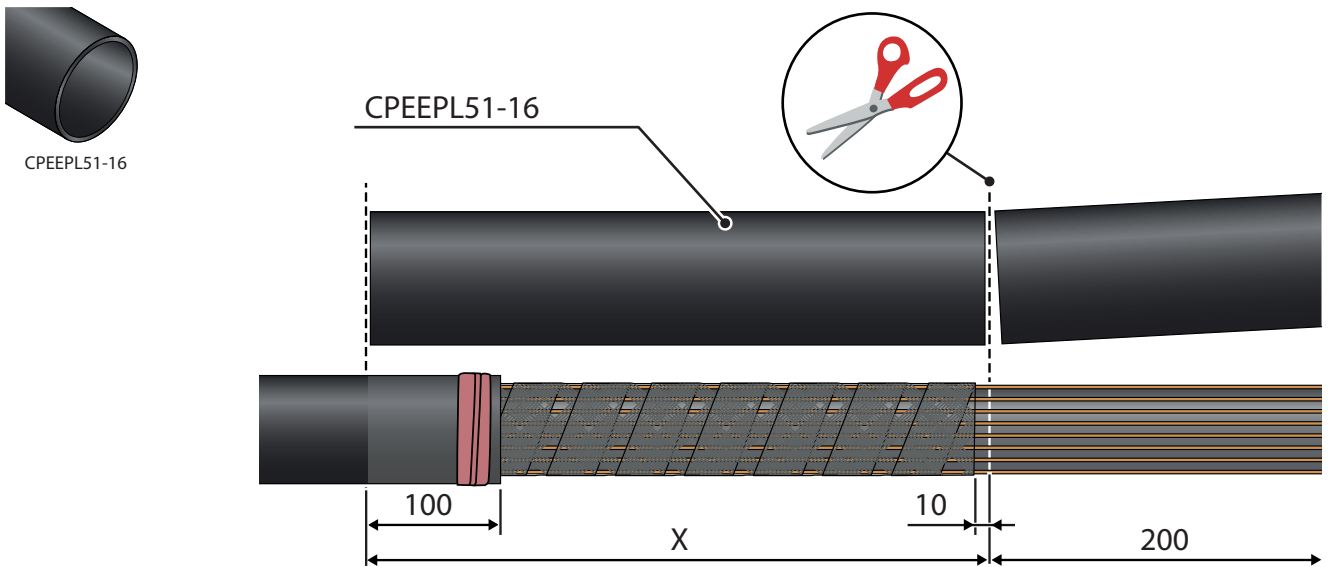

18

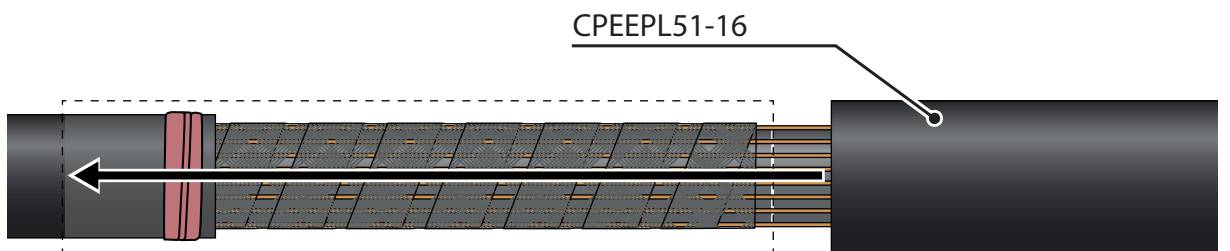

19

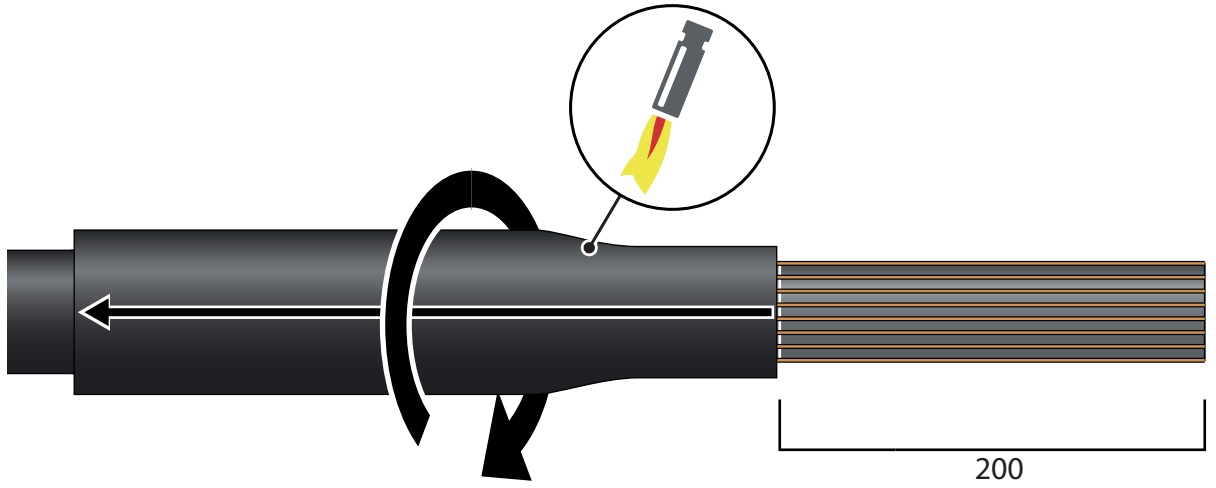

20

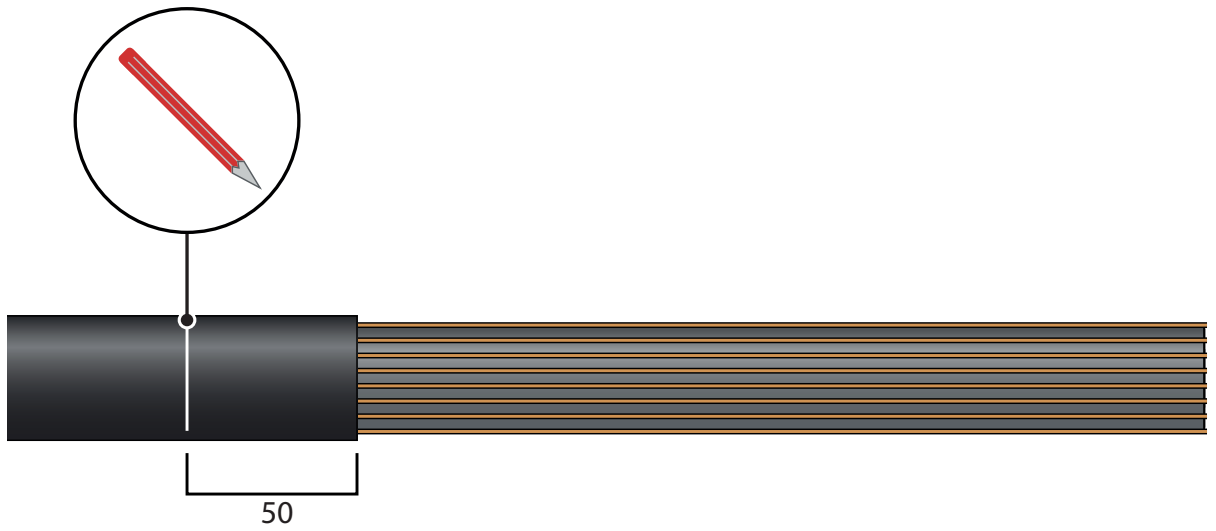

21

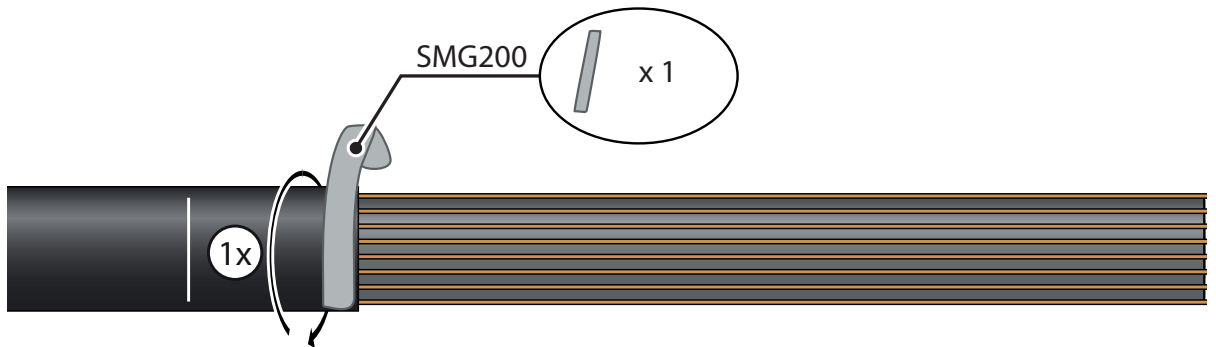
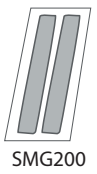

22

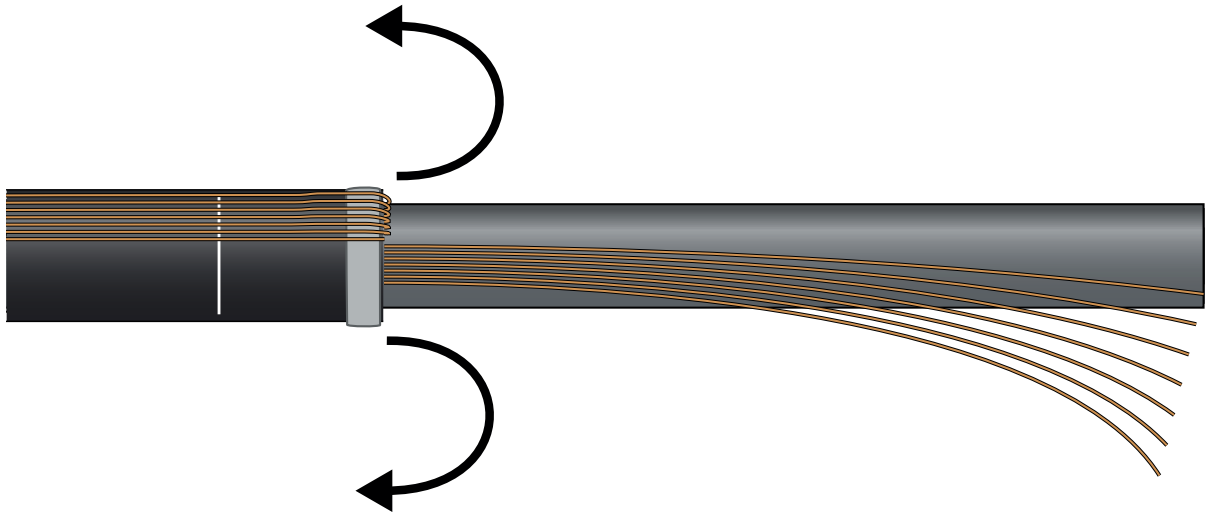

23

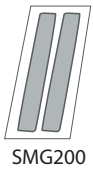

SMG200

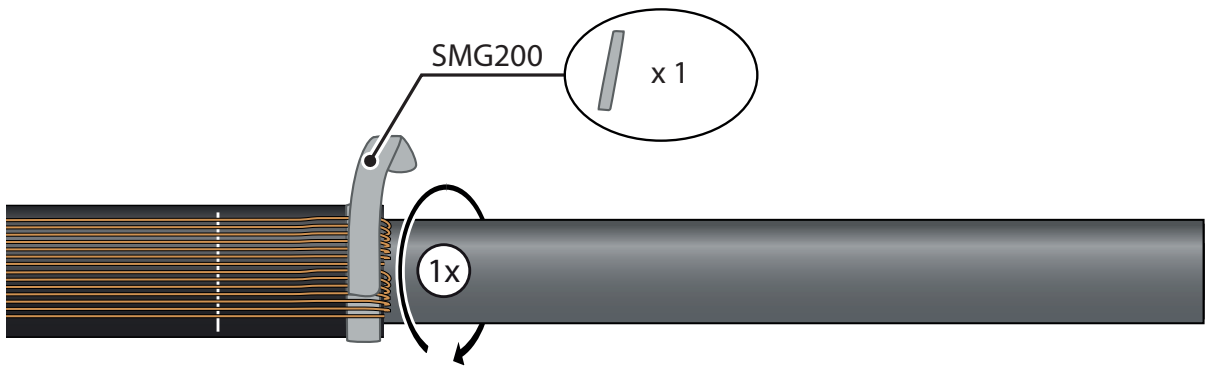

24

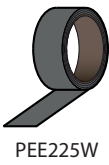

PEE225W

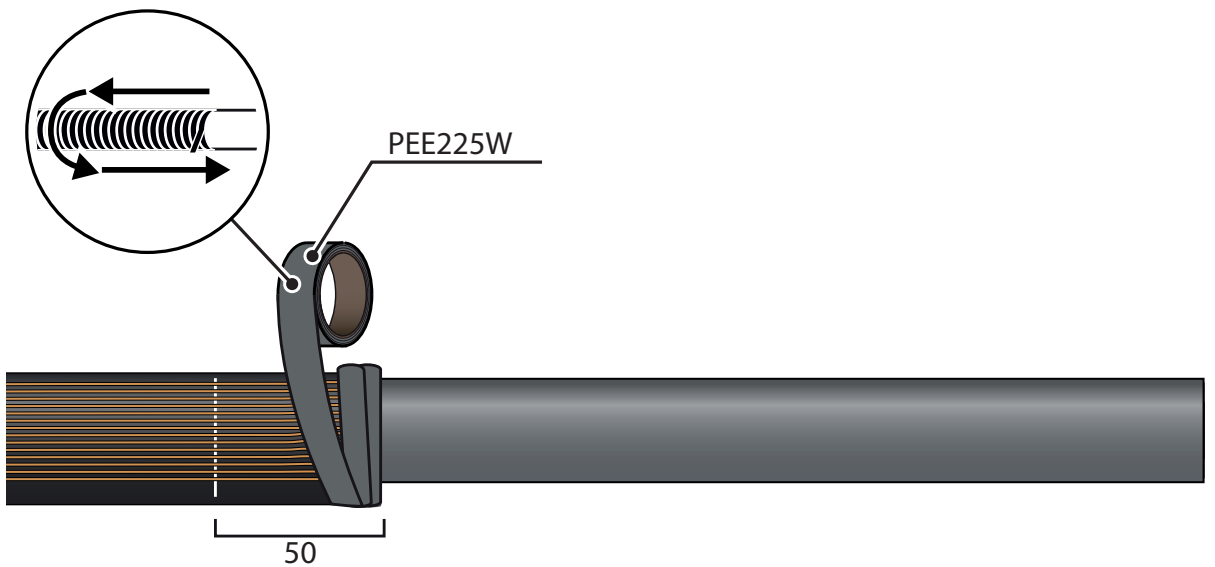

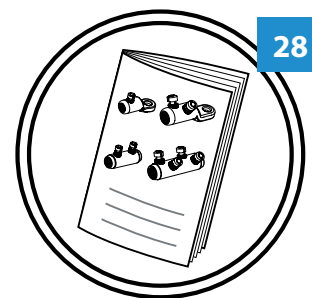
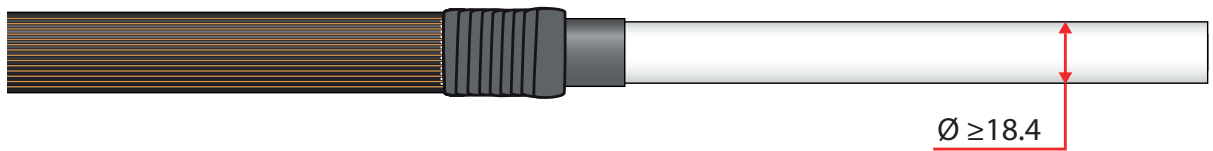
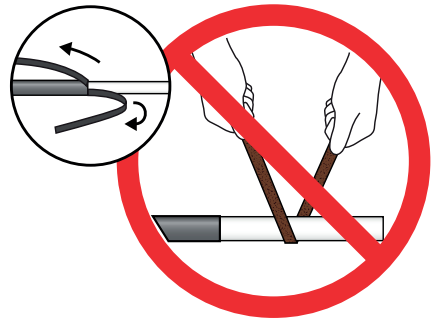
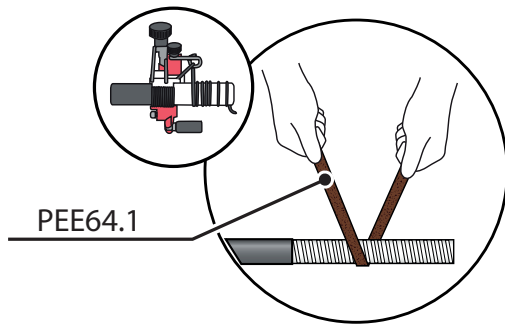
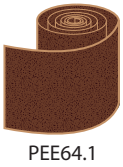
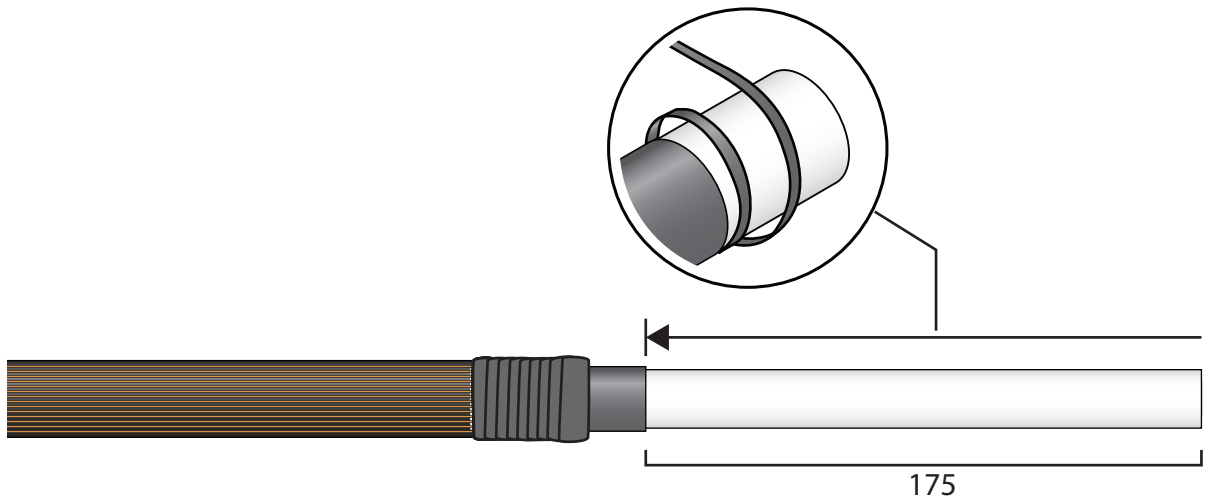



									
	mm	mm ²	mm ²	mm ²	mm	mm ²	mm ²	mm	mm
LA240N13SB2	7.7-19.2	50-240	90° 50-150 120° 50-120	90° 50-185 120° 50-150	60	50-95	120-150	d = 21 L _{min} = 26	13 mm

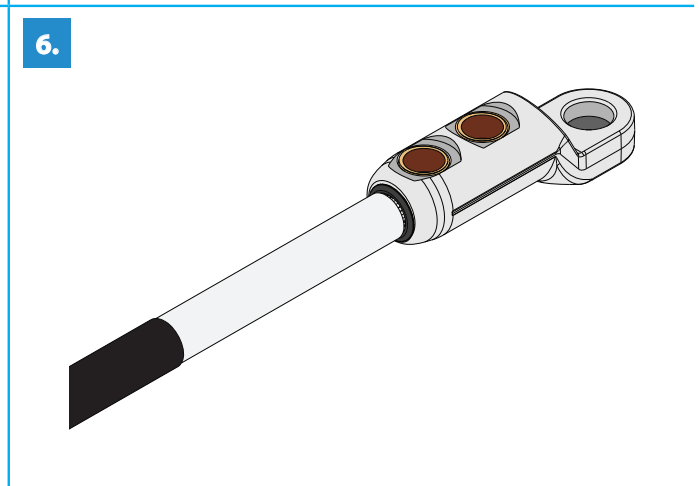
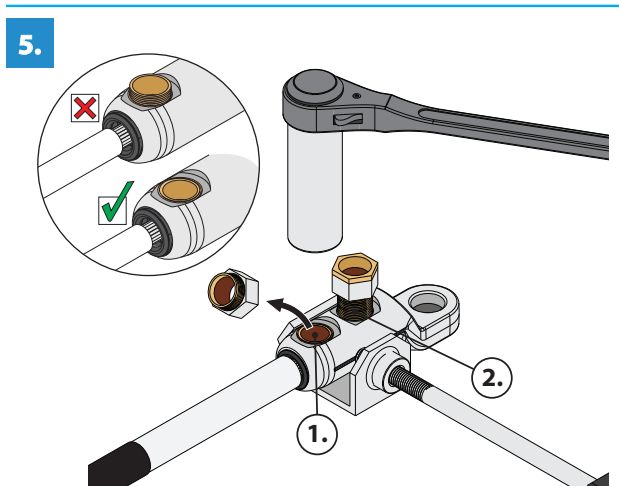
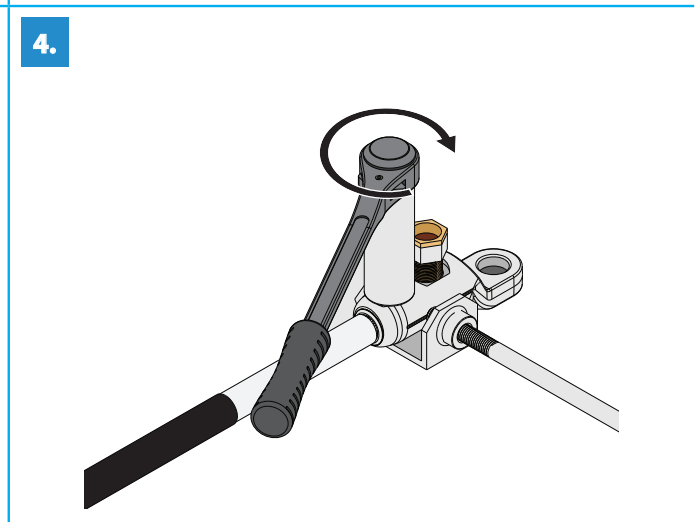
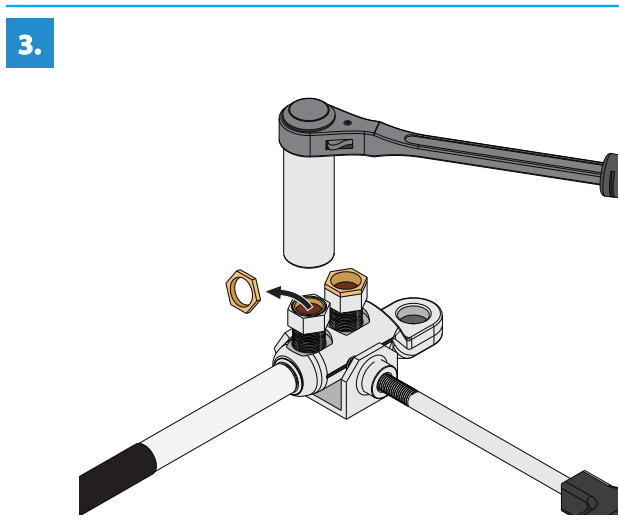
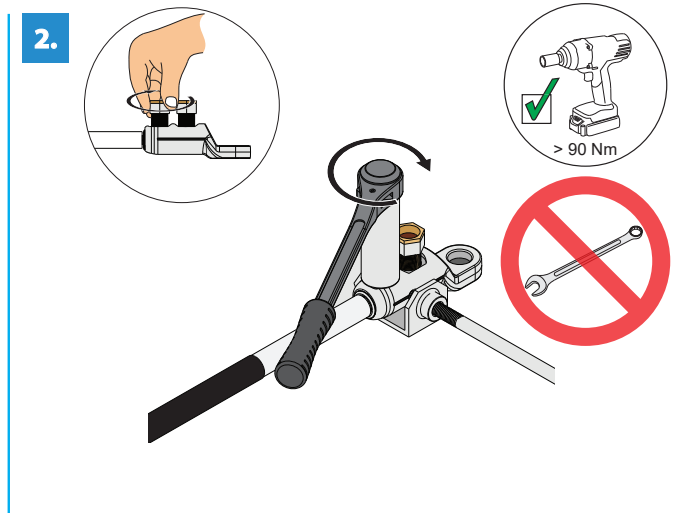
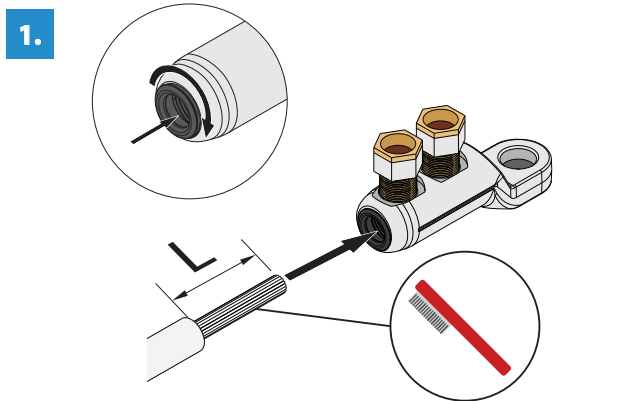

29



CT149

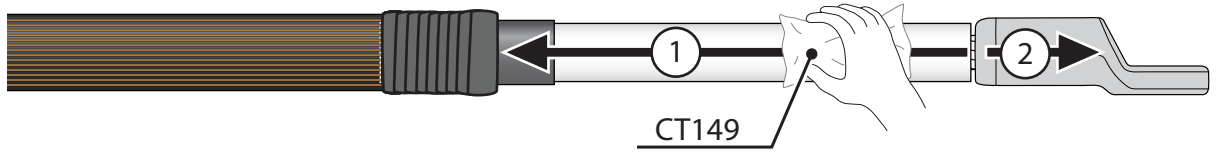
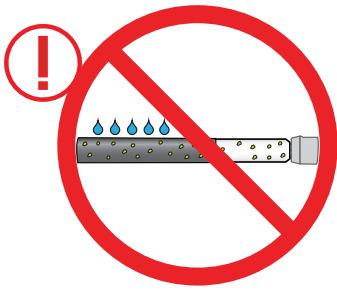

30

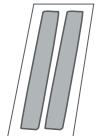

SMG200

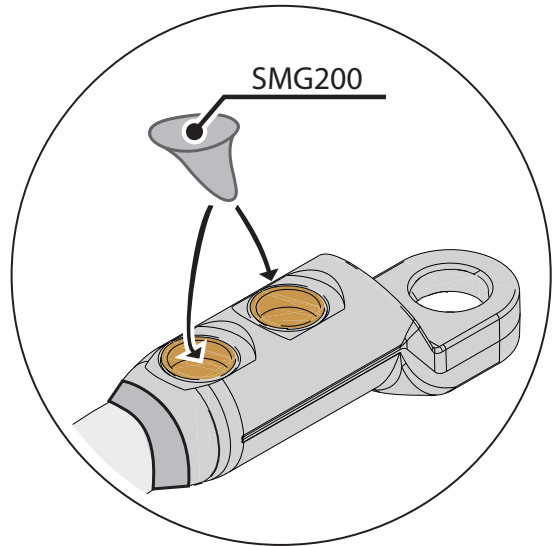
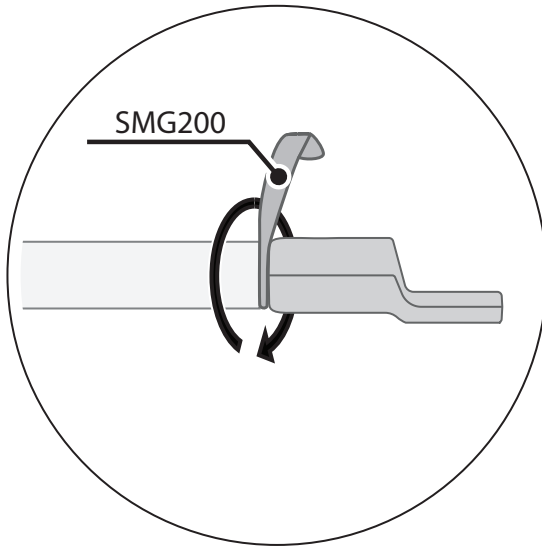

31



PEE225W

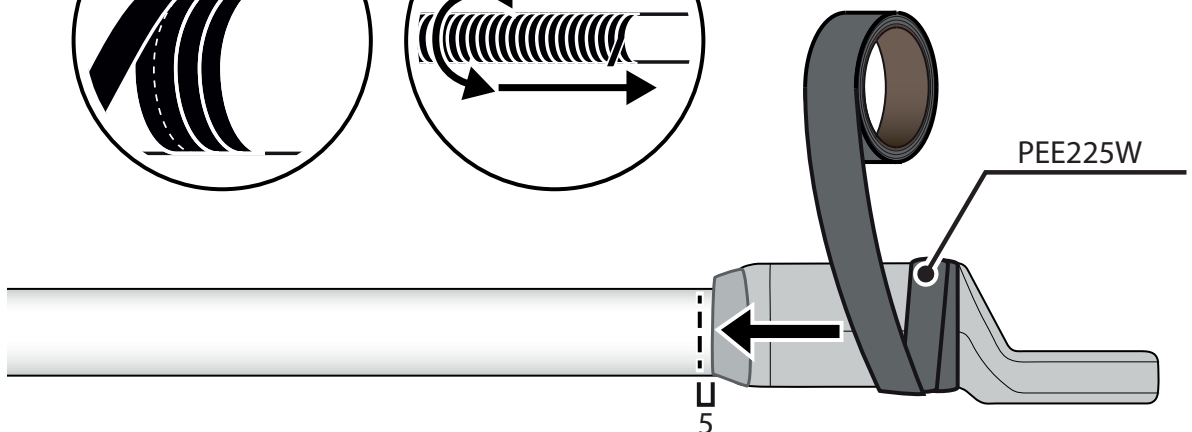
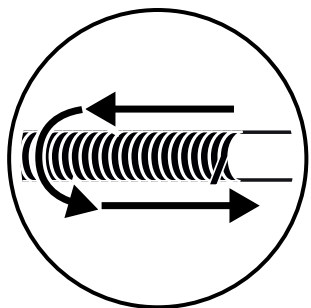
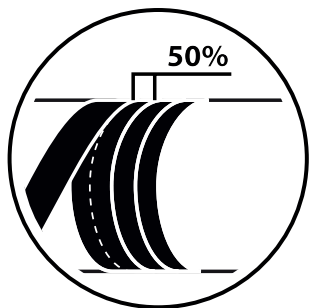

32



RFL15

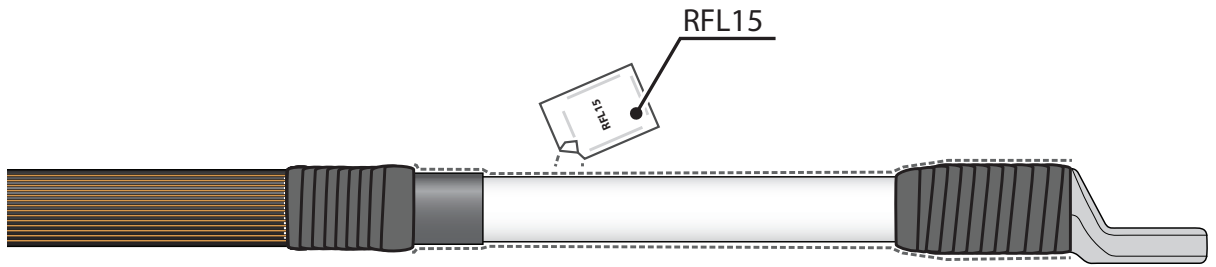

33

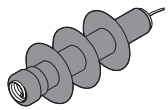

CTSAGEL16-45L

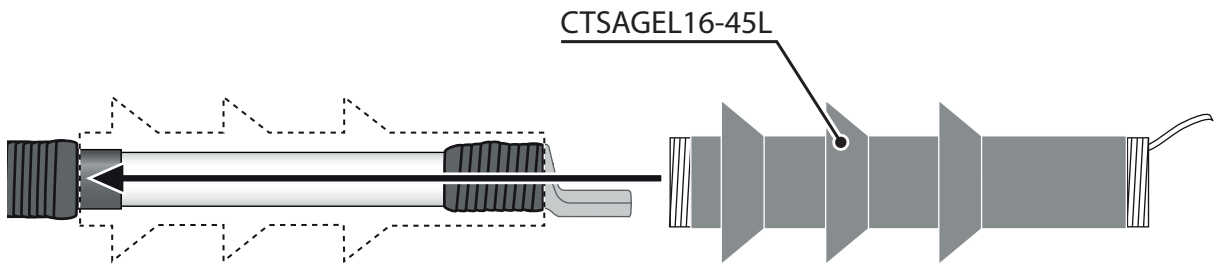

34

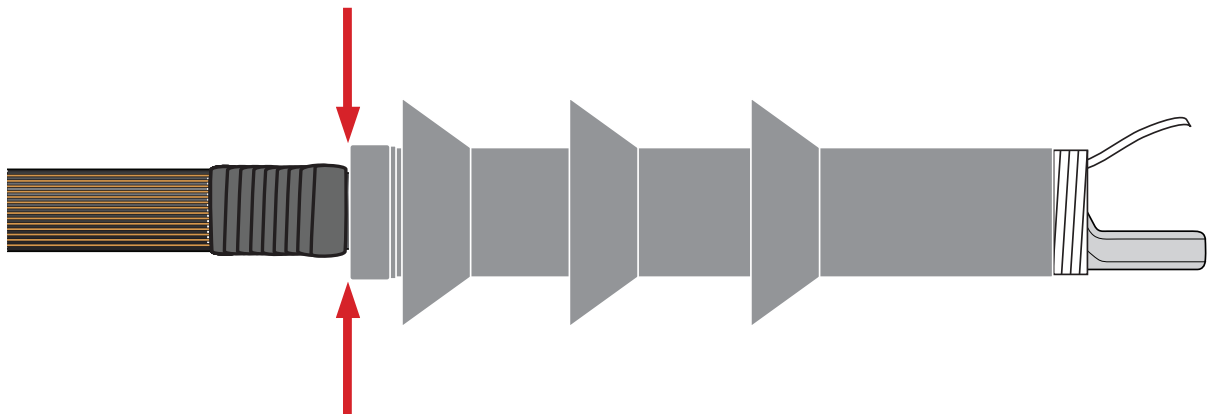

35

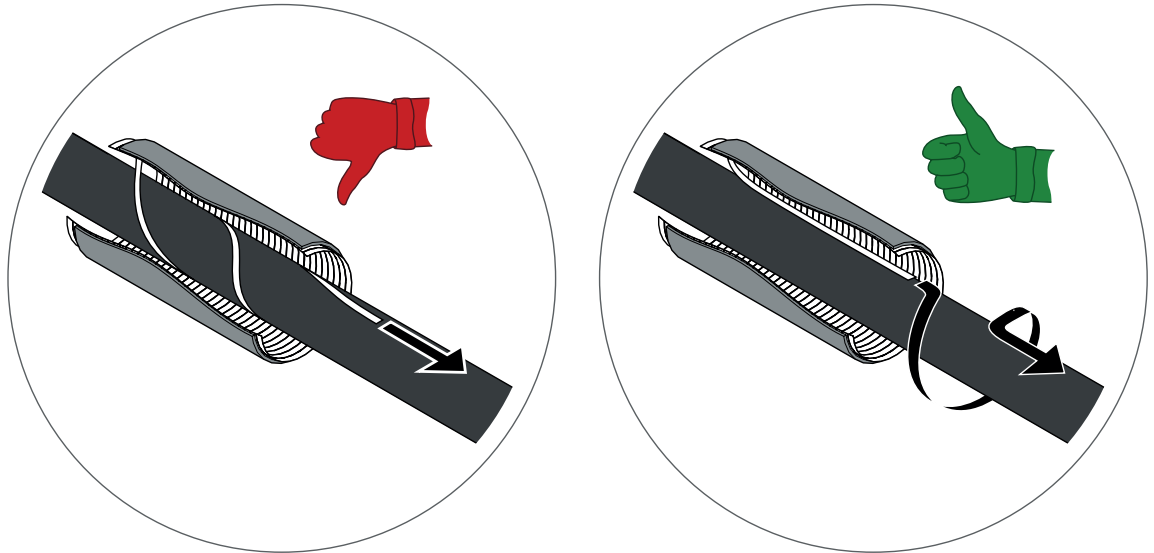

36

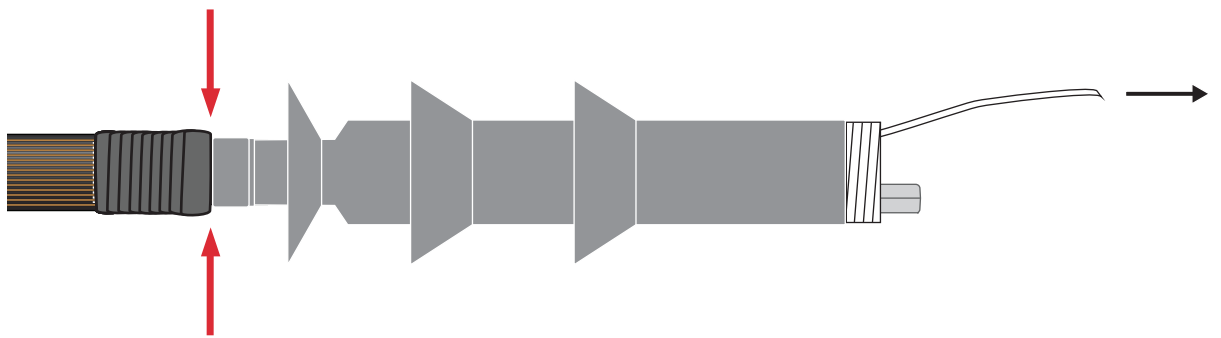

37

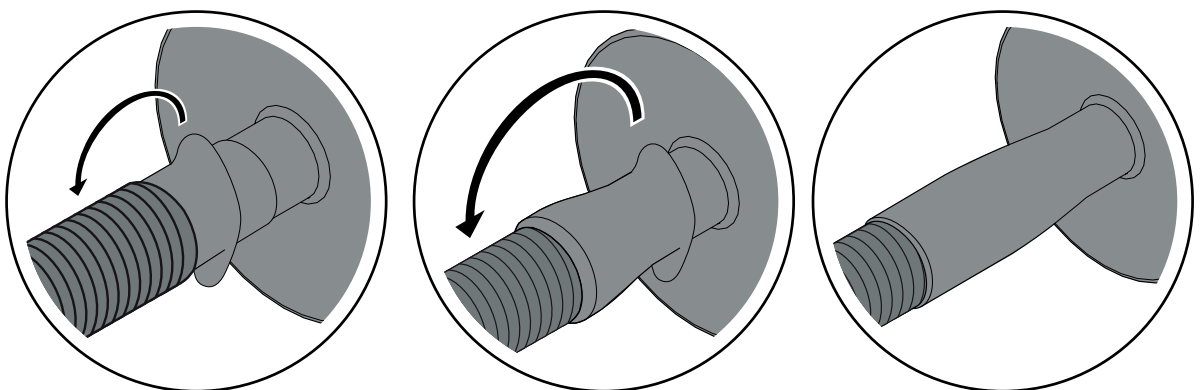

38

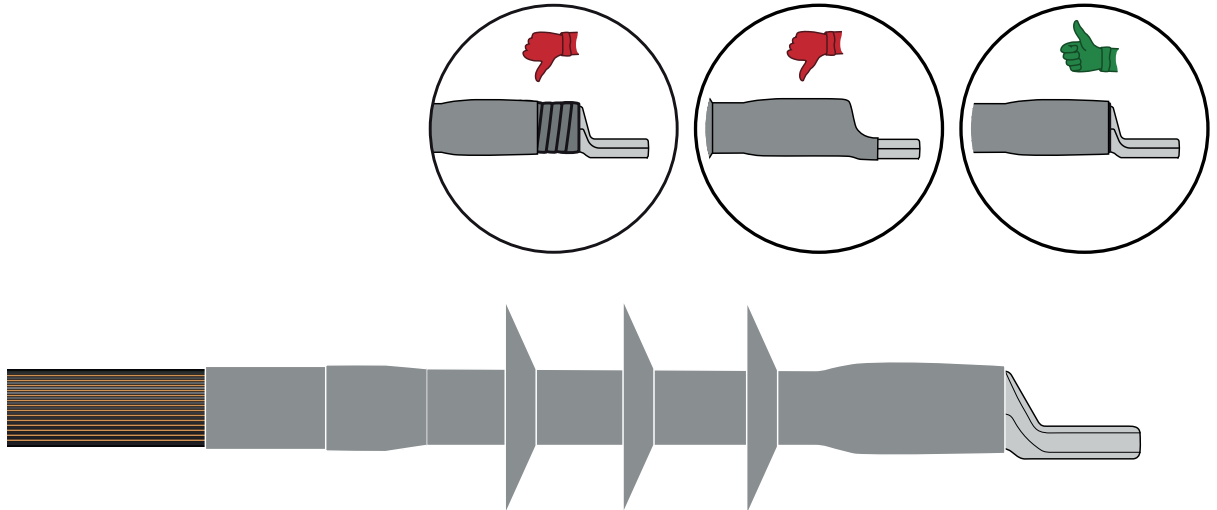

39

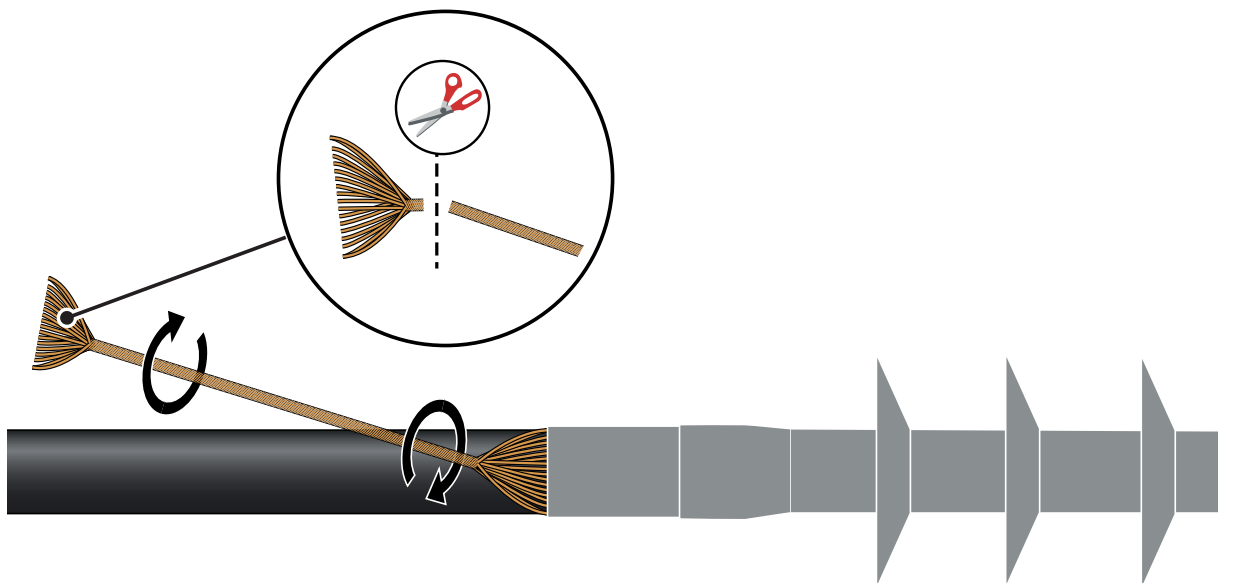

40

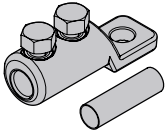

LUG6-50/12LVTIN

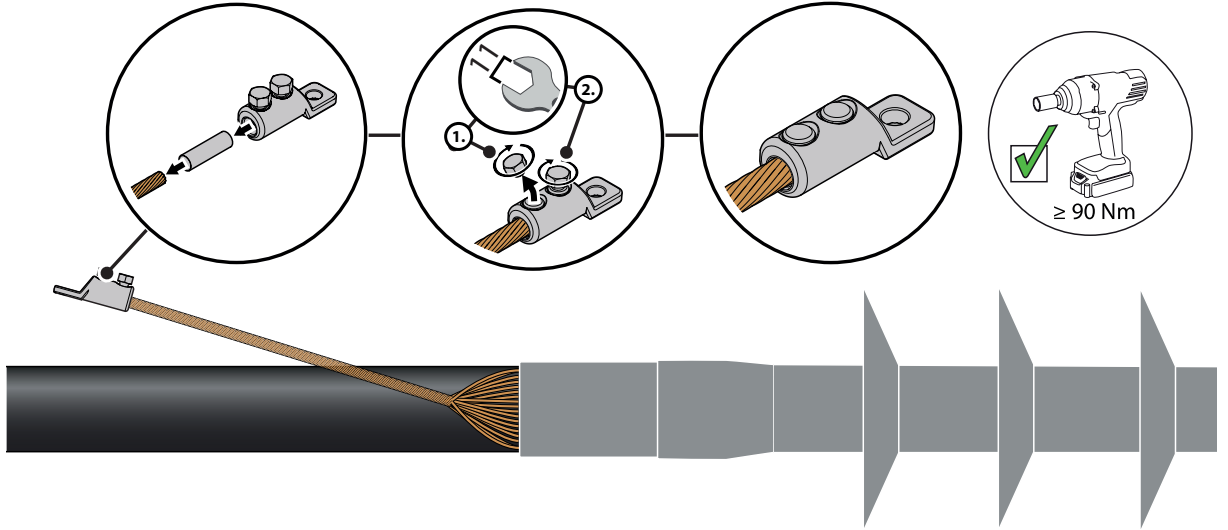

41





	12 kV	24 kV	36 kV	42 kV
a	§§§	§§§	§§§	§§§
b	§§§	§§§	§§§	§§§
c (mm)	15	25	35	45
d (mm)	10	20	25	35

§ § § = according to local requirements

ENSTO