

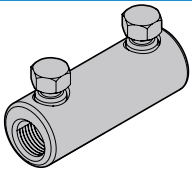





SJL50

$U_0/U (U_m)$ kV	 mm ²	 mm ²
0,6/1 (1,2) kV	16-50	16-50

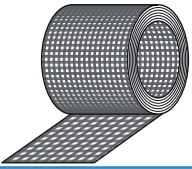
	SLJ1.27		1		PA23	1
	STCTA49.2	2000 mm	1		PEM-SJL50	1
	SSATA10		1			

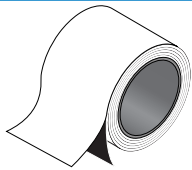
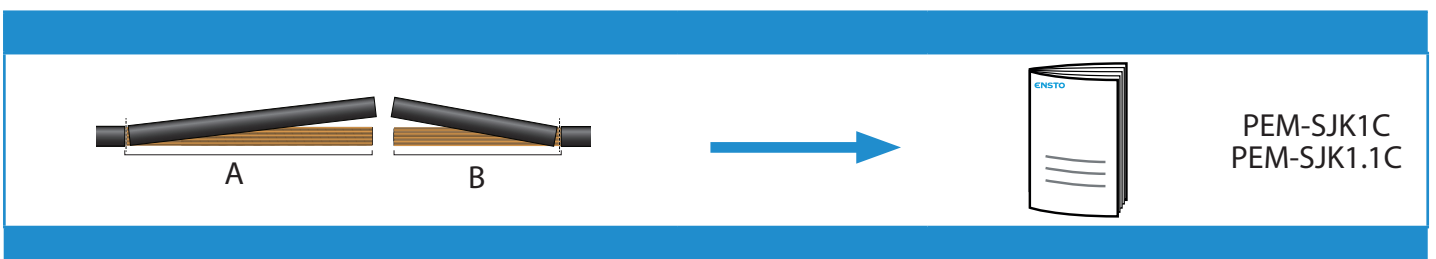

1

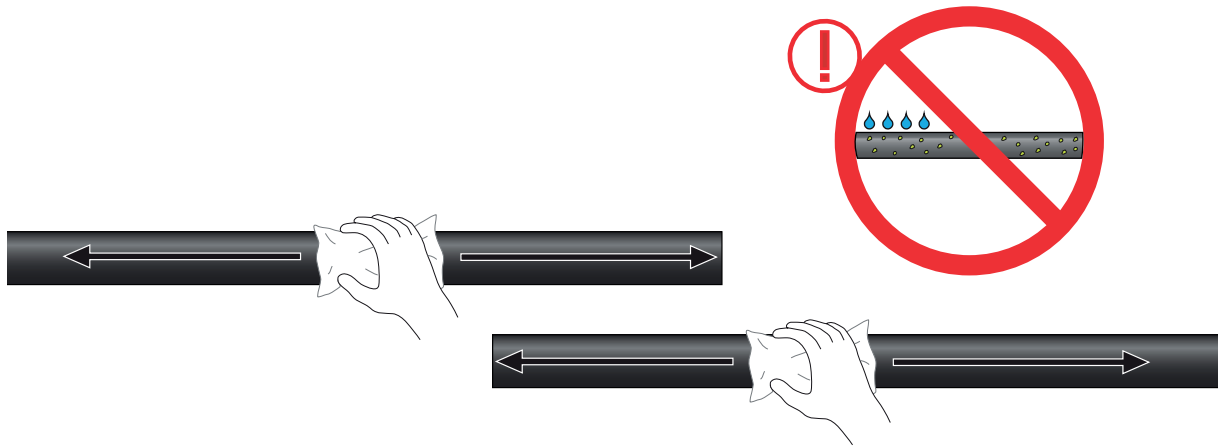

2

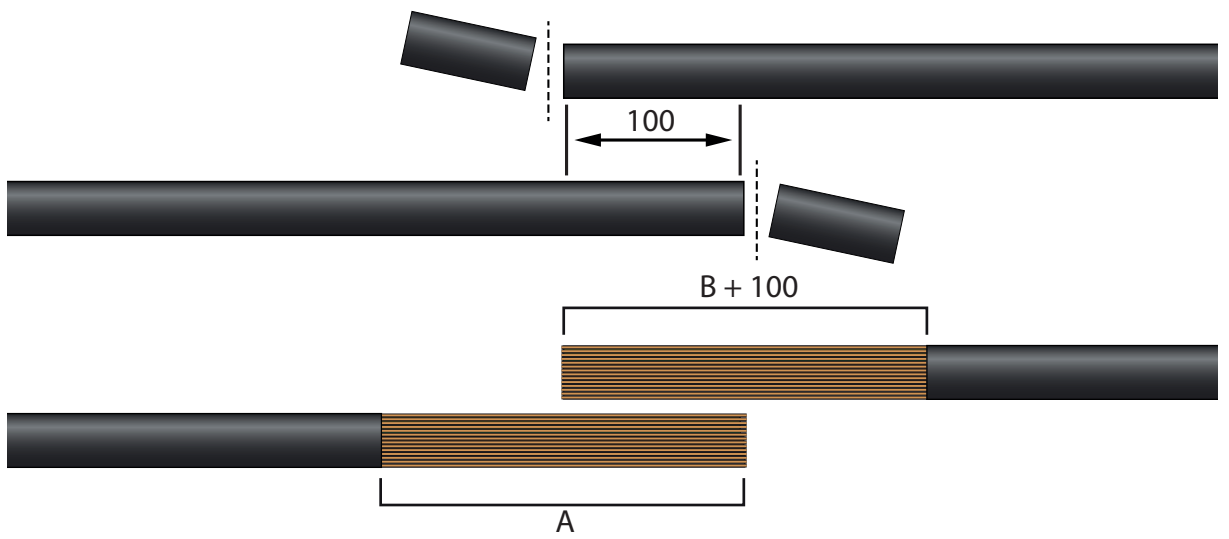

3



CPEEPL

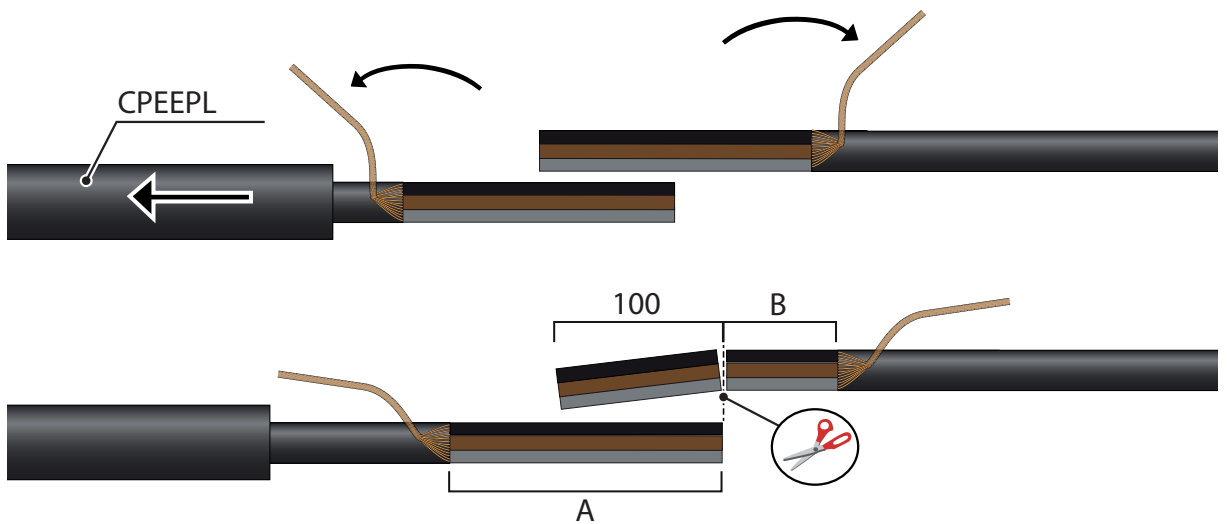

4

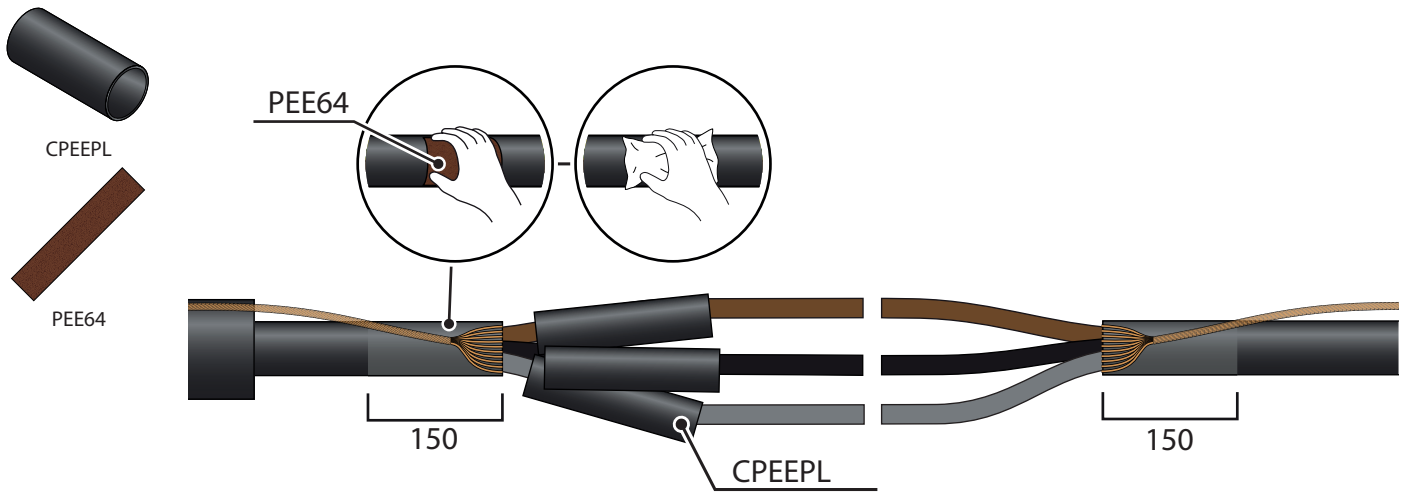

5

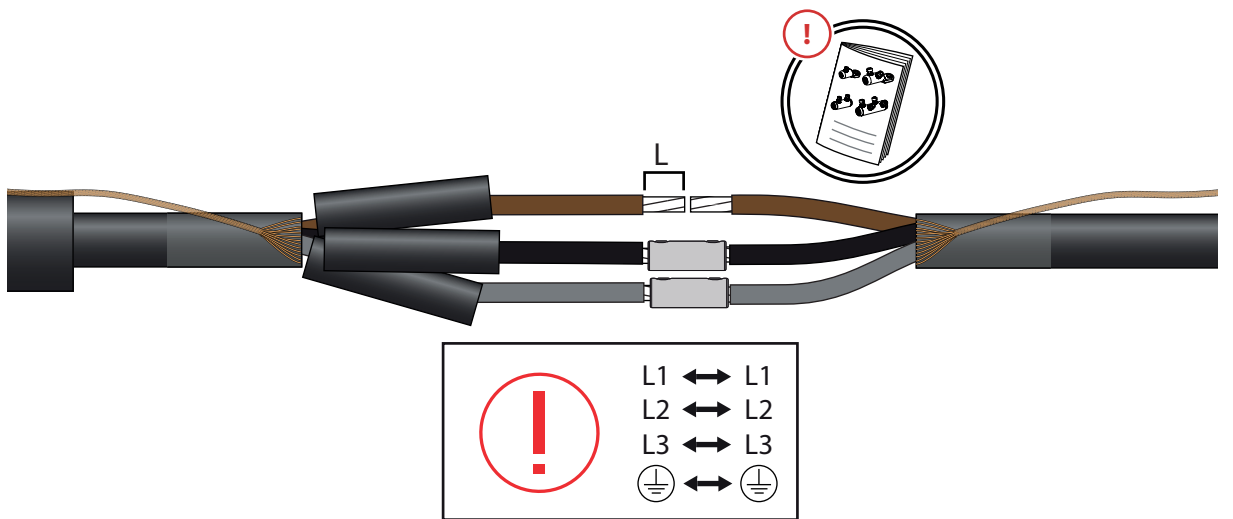

6

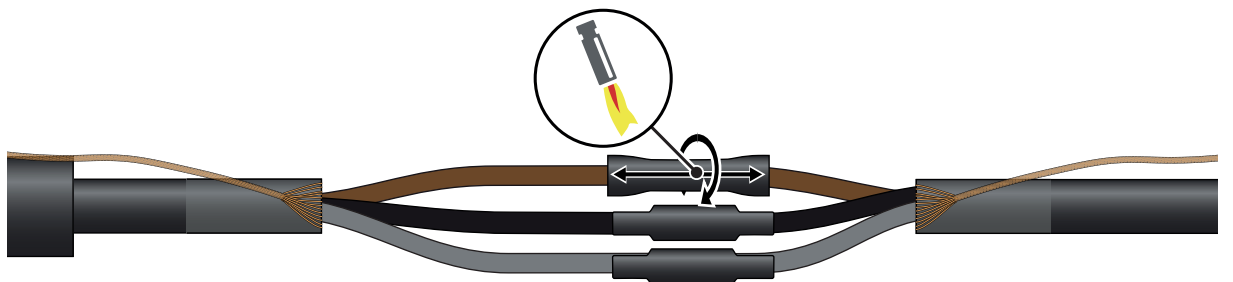

7

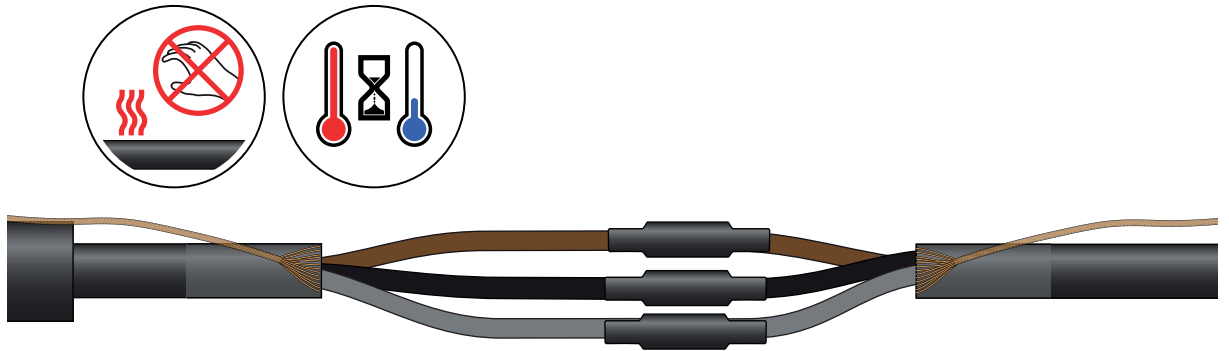

8

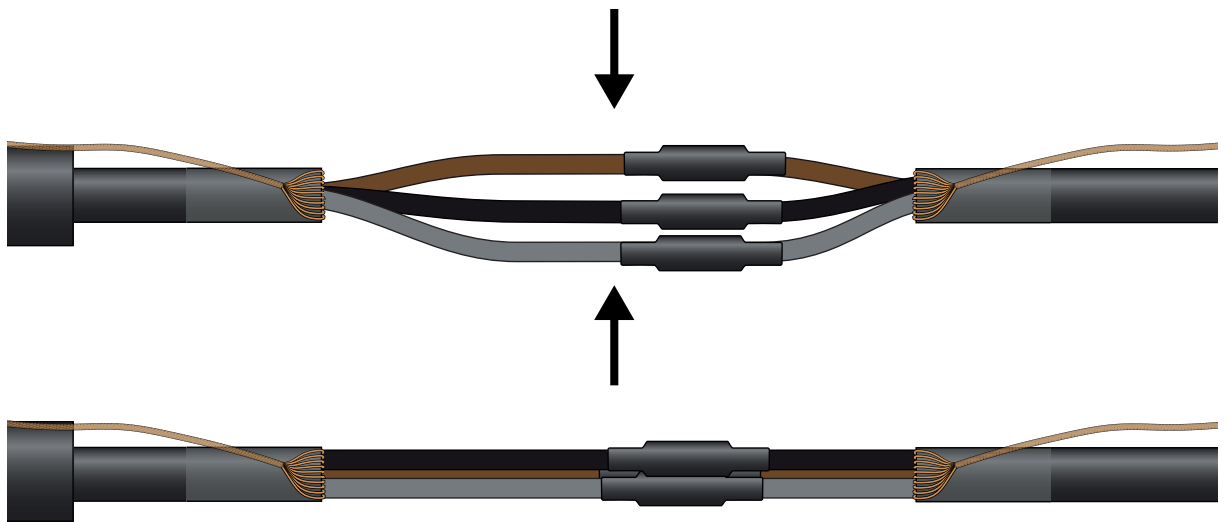

9

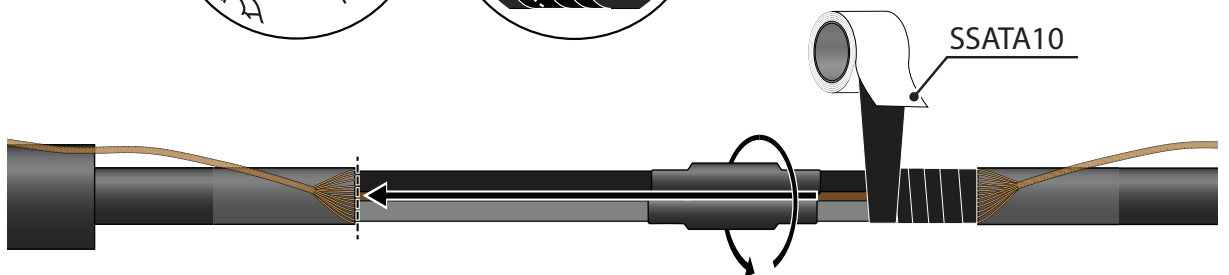
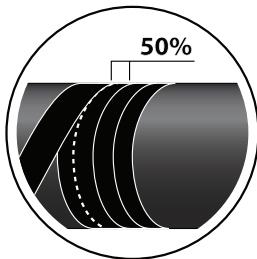
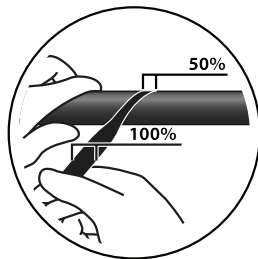

10

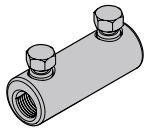

SLJ1.27

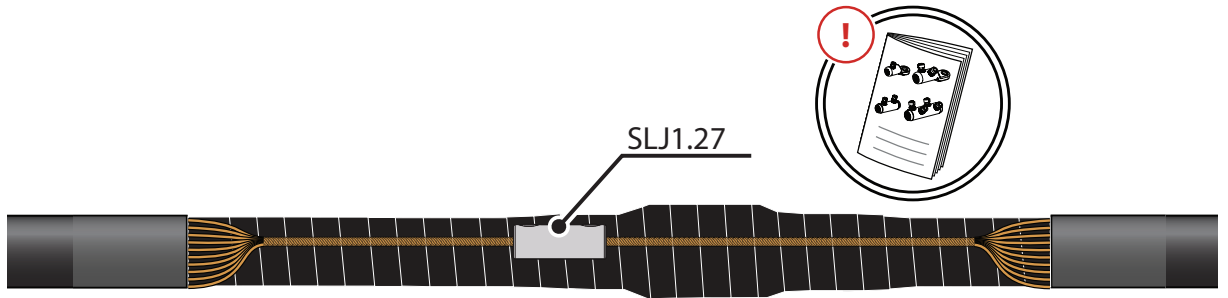

11

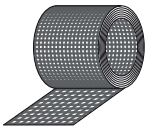

STCTA49

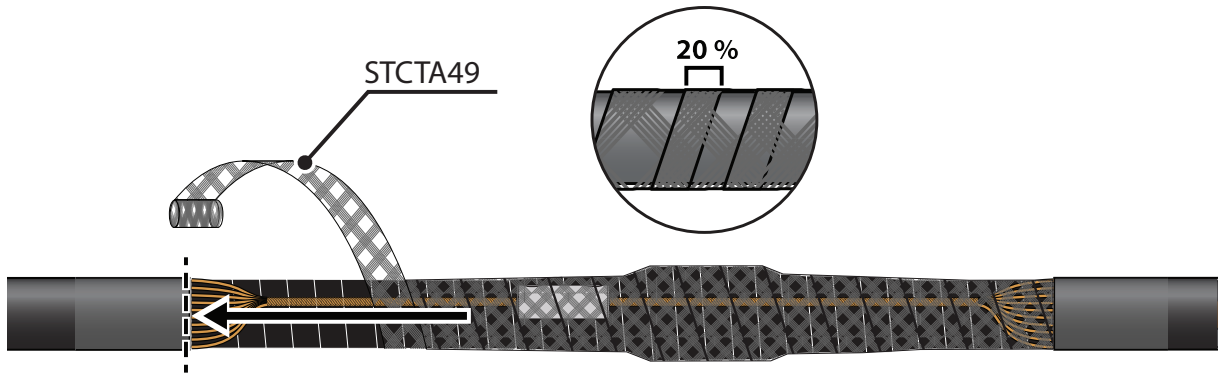

12

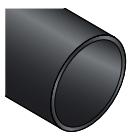

CPEEPL

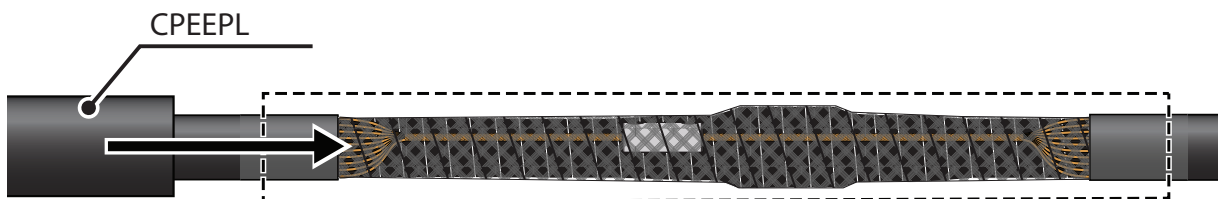

13

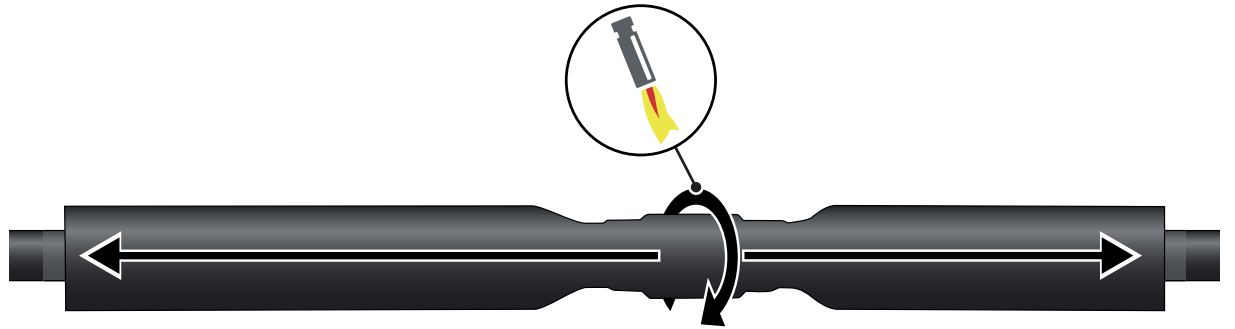

14

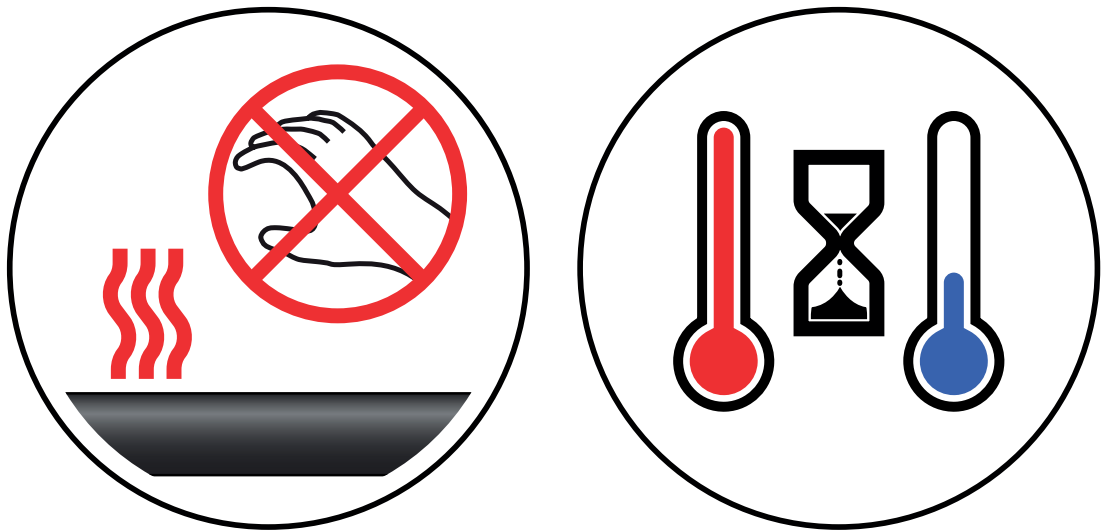

15

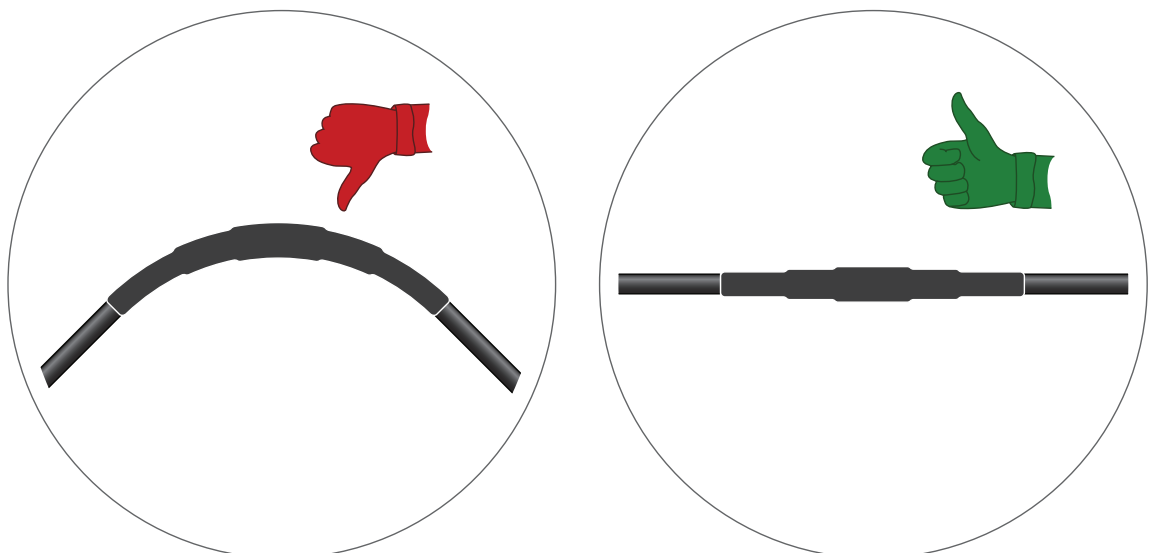

ENSTO