

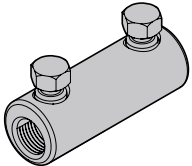

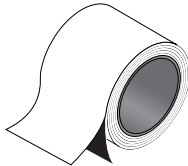

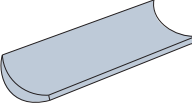

SJL185

$U_0/U(U_m)$ kV	 mm ²	 mm ²
0,6/1 (1,2) kV	50-185	50-185

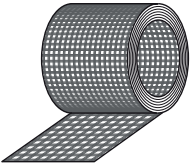
	SLJ2.27	1		SSATA10	2
	SLJT2 SLJT3	3 1		PA23	1
	STCTA49.6 6000 mm	1		PEM-SJL185	1

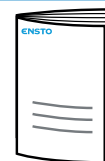

PEM-SJK2C
PEM-SJK2.1C
PEM-SJK25C
PEM-SJK25.1C
PEM-SJK3C

1

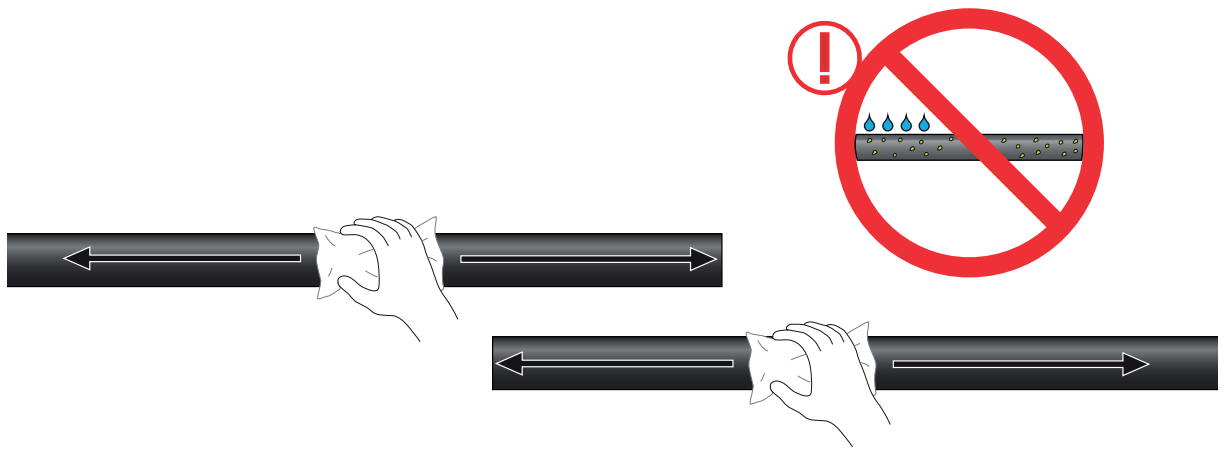

2

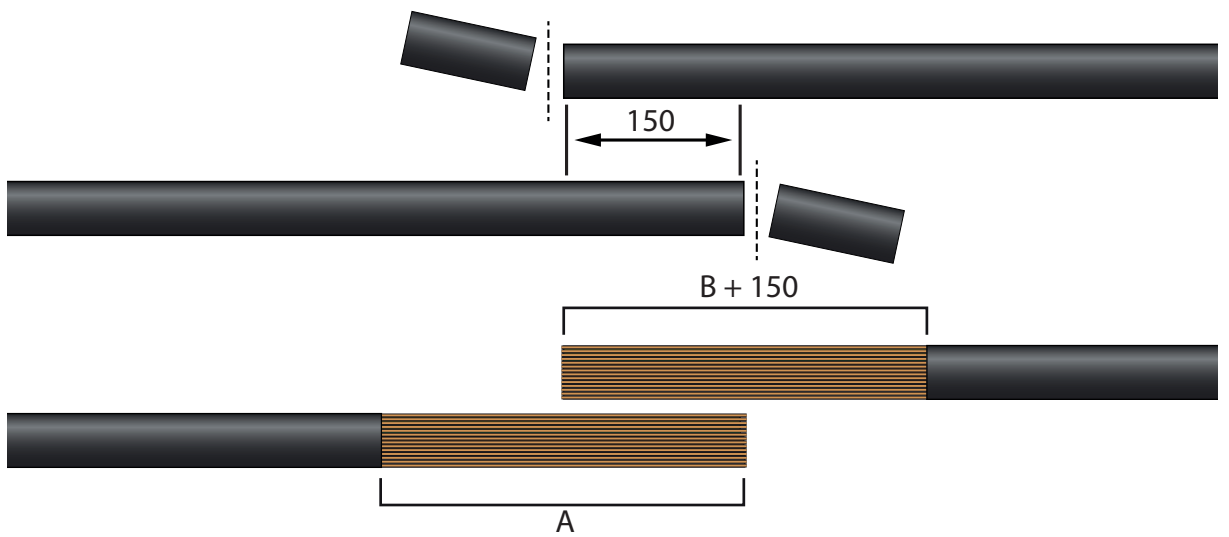

3

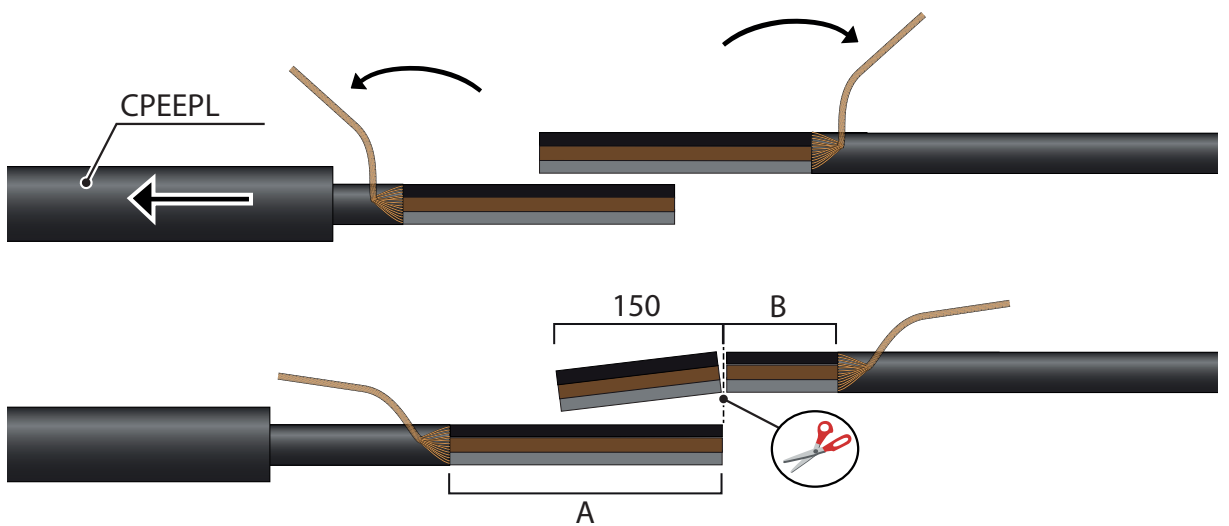

4

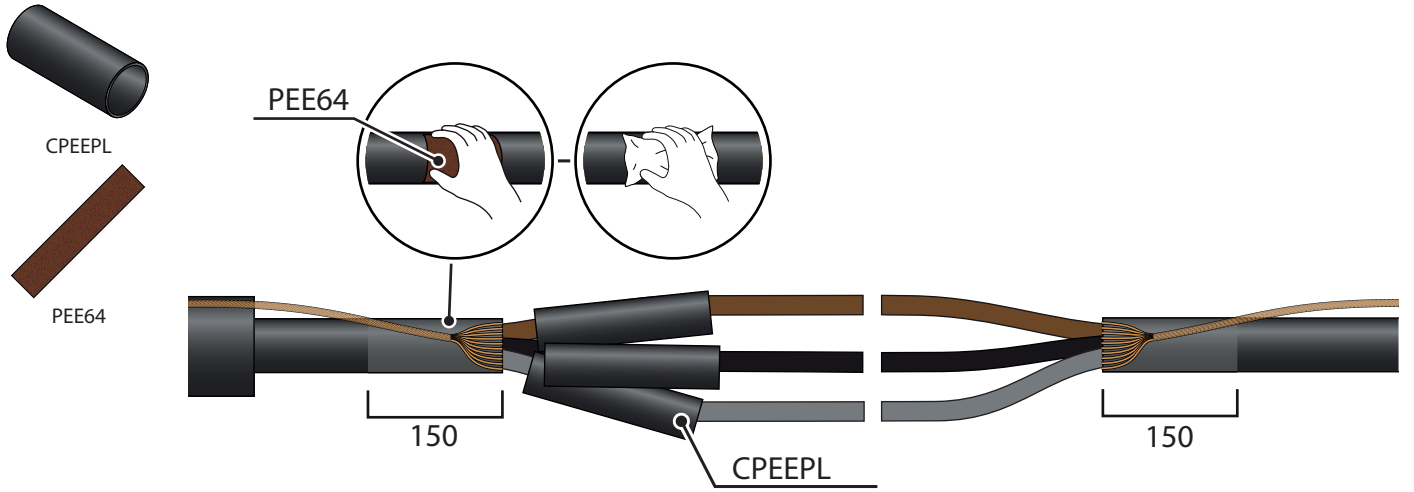

5

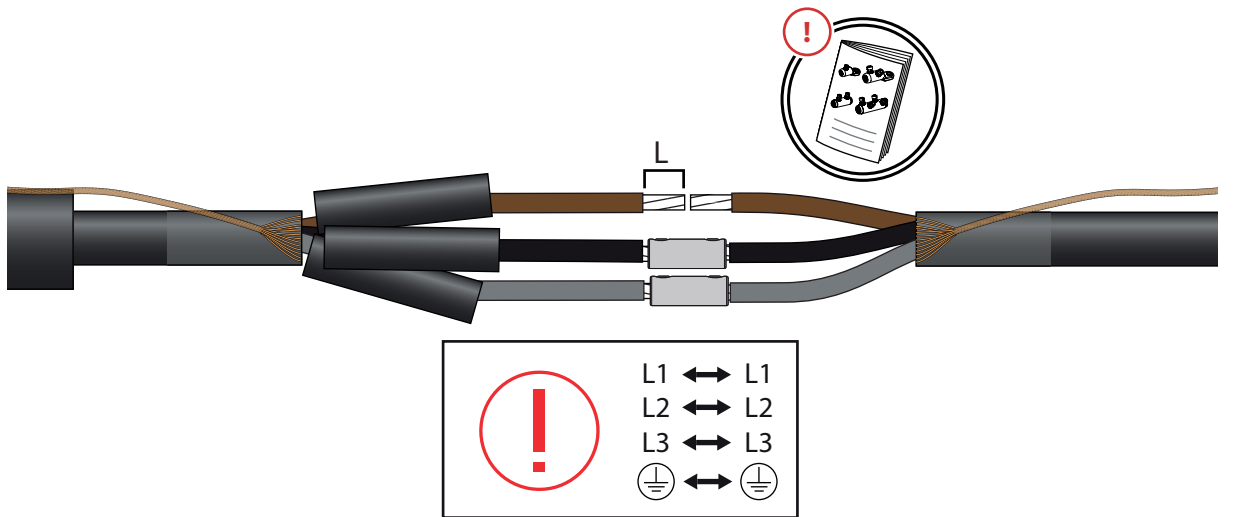

6

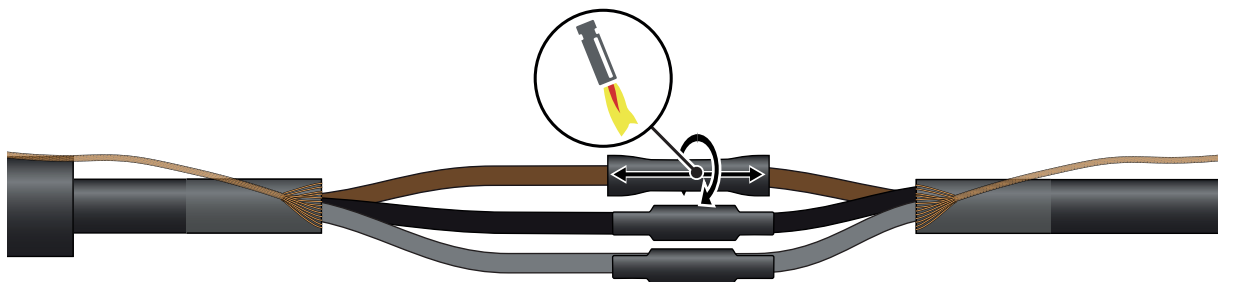

7

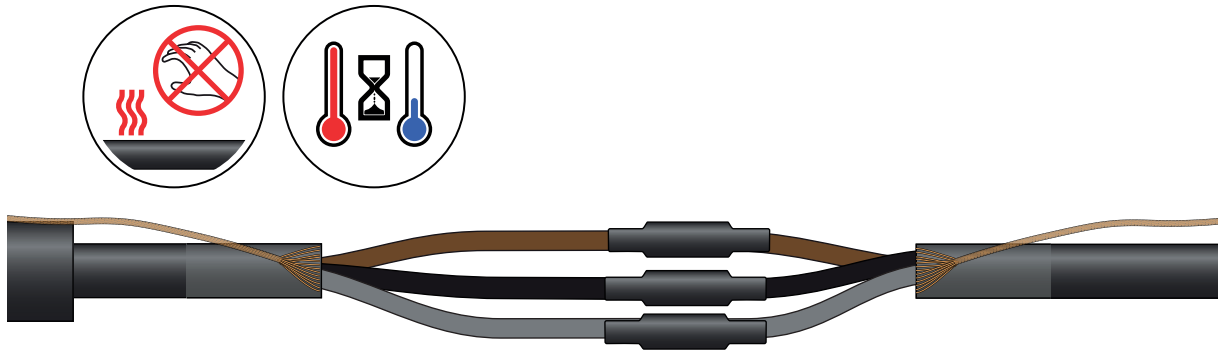

8

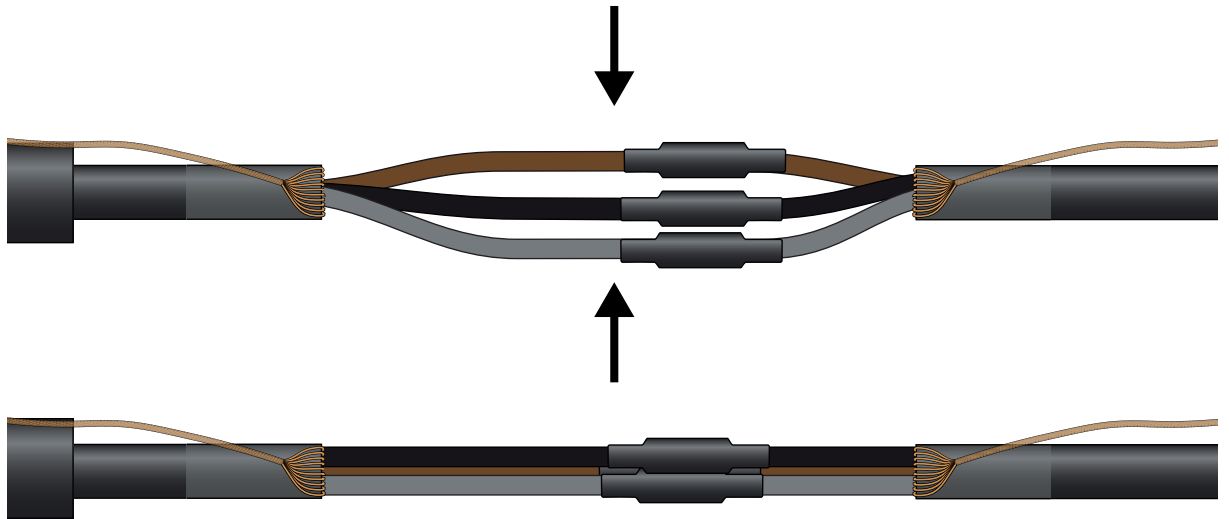

9

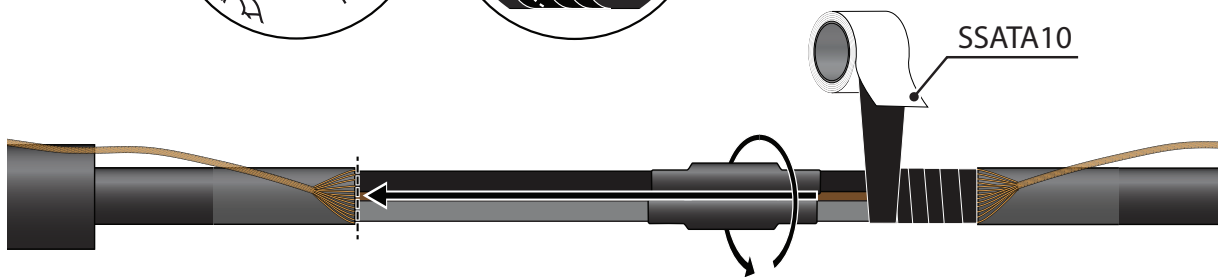
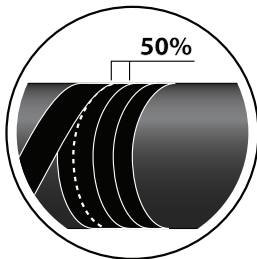
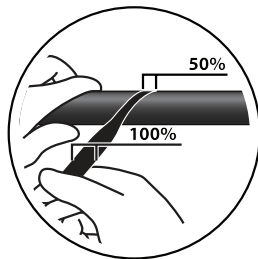

10

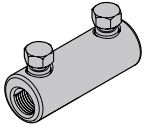

SLJ2.27

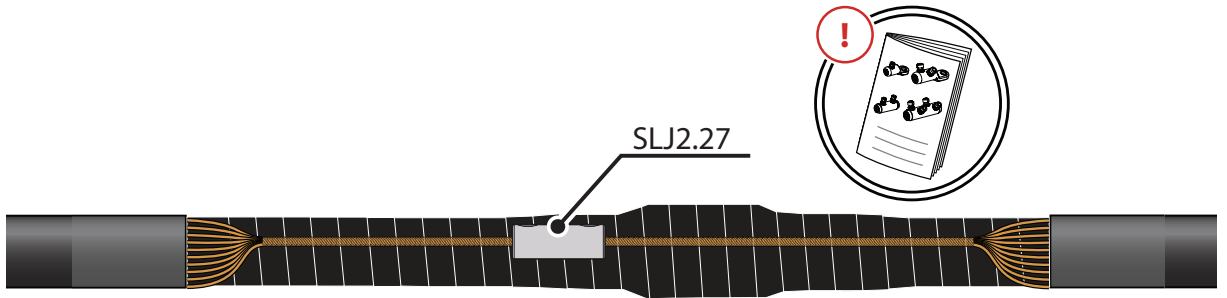

11

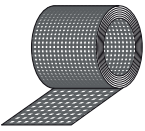

STCTA49

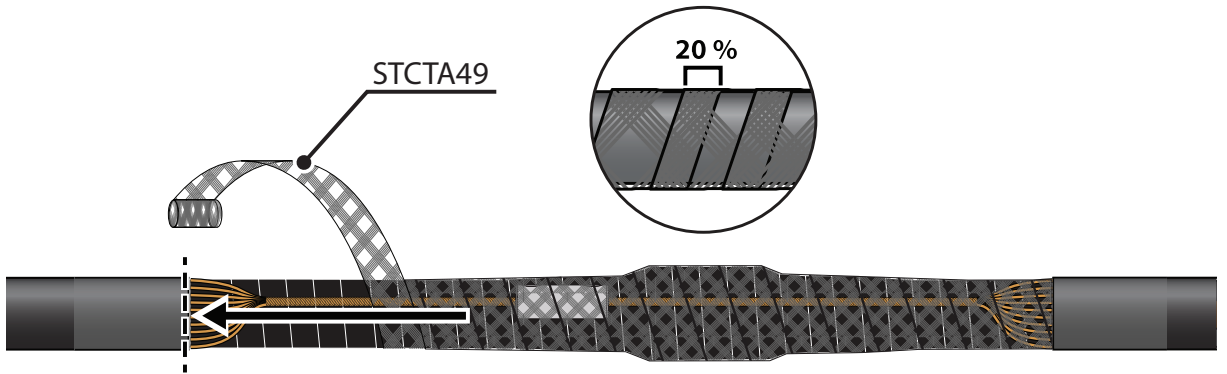

12

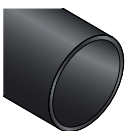

CPEEPL

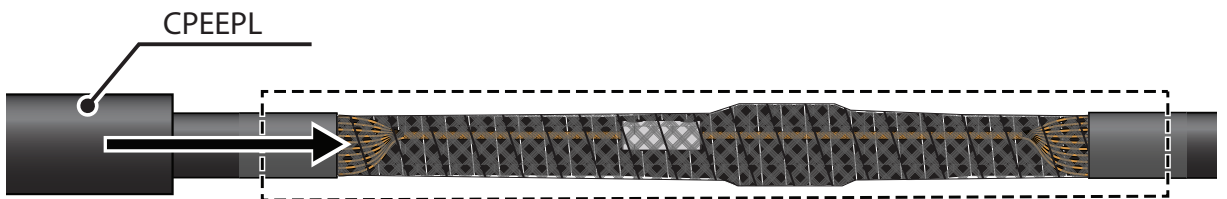

13

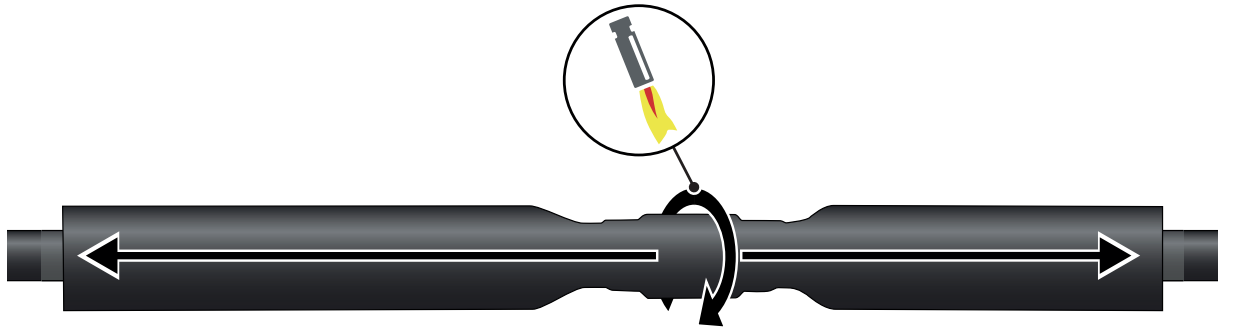

14

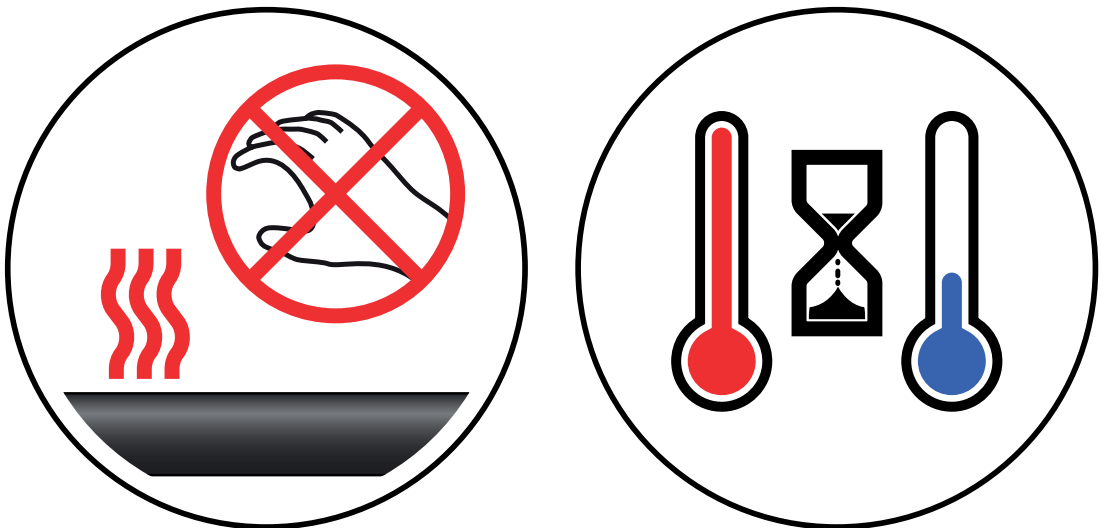

15

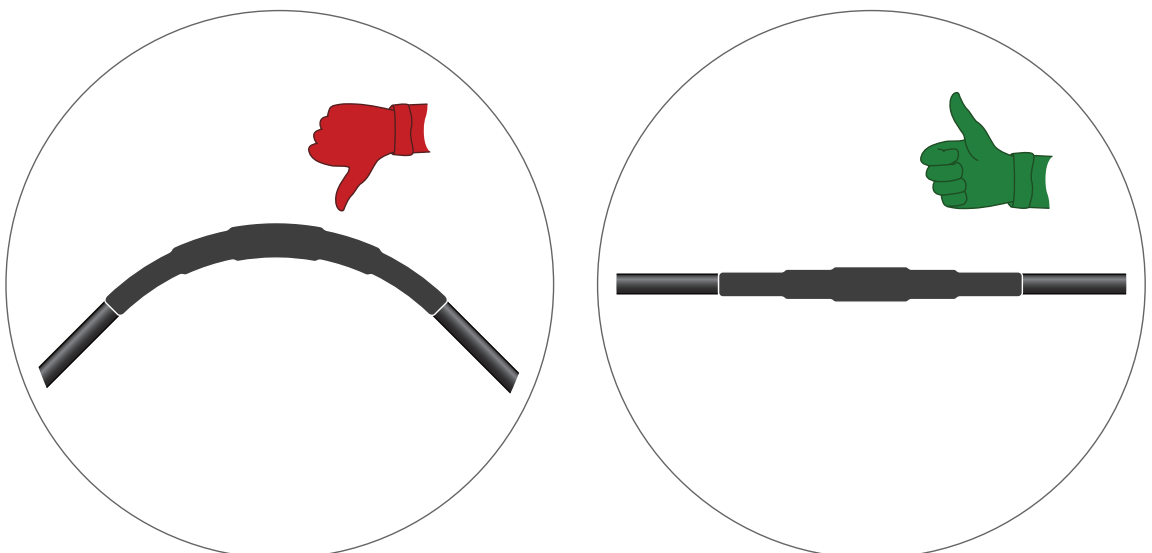

ENSTO